

**IMPORTANT!** Read and save these instructions. This manual to be left with the equipment.



# OPERATION AND MAINTENANCE MANUAL

Electrode Steam Humidifier  
Nortec **EL-Series**

# Thank you for choosing Condair

Installation date (DD/MM/YYYY):

Commissioning date (DD/MM/YYYY):

Site:

Model:

Serial number:

## **Proprietary Notice**

This document and the information disclosed herein are proprietary data of Condair Ltd. Neither this document, nor the information contained herein shall be reproduced, used, or disclosed to others without the written authorization of Condair Ltd., except to the extent required for installation, operation or maintenance of the customer's equipment.

## **Liability Notice**

Condair Ltd. does not accept any liability due to incorrect installation, maintenance or operation of the equipment, or due to the use of parts/components/equipment that are not authorized by Condair Ltd.

## **Copyright Notice**

© Condair Ltd, All rights reserved.

Technical modification rights reserved.

# Contents

---

<b>1</b>	<b>Introduction</b>	<b>5</b>
1.1	Before You Start!	5
1.2	General	5
<b>2</b>	<b>For Your Safety</b>	<b>7</b>
<b>3</b>	<b>Product Overview</b>	<b>9</b>
3.1	General Description	9
3.2	Functional Description	10
<b>4</b>	<b>Operator Interface</b>	<b>13</b>
4.1	Controls	13
4.2	Control Software	15
4.2.1	Home Screen	15
4.2.2	General Navigational Elements	16
4.2.3	Operating Status	16
4.2.4	Maintenance and Fault Status	17
4.2.5	Help	18
4.2.6	System Information	18
4.2.7	Main Menu	25
4.2.7.1	Configuration Menu	27
4.2.7.2	Service Menu	48
4.2.7.3	Administrator Menu	52
4.3	Software Configuration	54
4.3.1	Configuring the Control Software	54
4.3.2	Configuring for Multi-Unit Operation	55
<b>5</b>	<b>Operation</b>	<b>57</b>
5.1	General	57
5.2	Operating Procedures	58
5.2.1	Starting Up	58
5.2.2	Remote Monitoring	58
5.2.3	Inspections During Operation	59
5.2.4	Manually Initiate Steam Cylinder Draining	59
5.2.5	Exporting Trend Data	60
5.2.6	Shutting Down	62
5.2.7	Restarting After Shutdown	62
<b>6</b>	<b>Maintenance</b>	<b>63</b>
6.1	General	63
6.2	Maintenance List	64
6.2.1	Regular Replacement of Steam Cylinder(s)	64
6.2.2	Regular Maintenance of Steam Humidifier	64
6.3	Maintenance Procedures	65
6.3.1	Removal and Installation of Door Panels	65
6.3.2	Removal and Installation of Steam Cylinder	66
6.3.3	Removal and Installation of Drain Valve	68
6.3.4	Replacement of Backup Battery and Fuses	69

6.4	Cleaning	71
6.4.1	Cleaning Agents	71
6.4.2	Cleaning Procedures	71
6.5	Resetting Cylinder	72
6.6	Installing Software and Firmware Updates	73
<b>7</b>	<b>Fault Isolation</b>	<b>75</b>
7.1	General	75
7.2	Fault Indication	75
7.3	General Troubleshooting	76
7.4	Nortec EL Warning and Fault List	78
7.5	Exporting Fault and Service History	83
7.6	Resetting Fault Status	83
<b>8</b>	<b>Wiring Diagrams</b>	<b>85</b>
<b>9</b>	<b>Decommissioning</b>	<b>89</b>
9.1	General	89
9.2	Removal from Service for Disposal or Long-term Storage	90
9.3	Disposal/Recycling	90
<b>10</b>	<b>Product Specifications</b>	<b>91</b>
10.1	Performance Data	91
10.2	Operating Data	91
10.3	Size and Weight	92
10.3.1	Size	92
10.3.2	Weight	92

# 1 Introduction

## 1.1 Before You Start!

Thank you for purchasing the Nortec EL steam humidifier.

The Nortec EL steam humidifier incorporates the latest technical advances and meets all recognized safety standards. Never-the-less, improper use of the Nortec EL steam humidifier may result in danger to the user or third parties, and/or damage to property.

To ensure safe, proper and economical operation of the Nortec EL steam humidifier, observe and comply with all information and safety instructions contained in this manual, as well as all relevant documentation of components of the installed humidification system.

If you have additional questions, contact your local Condaire representative. They will be glad to assist you.

## 1.2 General

### Limitations

The subject of this manual is the Nortec EL steam humidifier. The various options and accessories may only be described in-so-far as is necessary for proper operation of the equipment. Additional information on options and accessories can be obtained in the instructions that are supplied with them.

This manual is restricted to the operation and maintenance of the Nortec EL steam humidifier, and is intended for well trained personnel who are suitably qualified for their respective tasks.

### Symbols Used in This Manual



#### CAUTION!

The word "CAUTION" in conjunction with the general caution symbol is used to provide safety instructions that, if neglected, may cause damage and/or malfunction of the unit or damage to property.



#### WARNING!

The word "WARNING" in conjunction with the general warning symbol is used to provide safety instructions that, if neglected, may cause injury to personnel. Other specific warning symbols may also be used in place of the general symbol.



#### DANGER!

The word "DANGER" in conjunction with the general danger symbol is used to provide safety instructions that, if neglected, may cause severe injury to personnel or even death. Other specific danger symbols may also be used in place of the general symbol.

**Other Related Publications**

This operation manual is supplemented by other publications such as the installation manual, spare parts list, etc., which are included in the delivery of the equipment. Where necessary, appropriate cross-references to these publications have been added in this manual.

**Storage of Manual**

Keep this manual in a place where it is safe and readily accessible. If the equipment is moved to another location, make sure that the manual is passed on to the new user.

If the manual is lost or misplaced, contact your local Condair representative for a replacement copy.

## 2 For Your Safety

### General

Every person who is tasked with the operation and maintenance of the Nortec EL steam humidifier must read and understand this manual before performing any work. Knowing and understanding the contents of the operation manual is a basic requirement for protecting personnel against any kind of danger, preventing faulty operation, and operating the unit safely and correctly.

All labels, signs and marking applied to the Nortec EL steam humidifier must be observed and kept in a readable state.

### Personnel Qualifications

All procedures described in this manual must only be performed by personnel who are adequately qualified, well trained and are authorized by the customer.

For safety and warranty reasons, any activity beyond the scope of this manual must only be performed by qualified personnel authorized by Conair.

All personnel working with the Nortec EL steam humidifier must be familiar with, and comply with the appropriate regulations on workplace safety and prevention of accidents.

### Intended Use

The Nortec EL steam humidifier is intended exclusively for air humidification using a Conair-approved steam distributor or blower pack within specified operating conditions (refer to ["Operating Data" on page 91](#) for details). Any other type of application, without the express written consent of Conair, is considered to be not conforming to its intended purpose, and may lead to dangerous operation and will void the warranty.

In order to operate the equipment in the intended manner all information contained in this manual, in particular the safety instructions, must be observed closely.

### Dangers that may arise from the Nortec EL steam humidifier:



**DANGER!**  
Risk of electric shock!

**The Nortec EL steam humidifier is mains powered. Live parts may be exposed when the door panels are removed. Touching live parts may cause severe injury or even death.**

**Prevention:** Before performing any work inside the Nortec EL steam humidifier, shut down the humidifier properly and secure it against accidental power-up as described in ["Shutting Down" on page 62](#).



**WARNING!**  
Risk of severe burns from exposure to hot steam vapours!

**The Nortec EL steam humidifier produces hot steam vapours. Contact with the hot steam vapours can result in severe burns.**

**Prevention:** Never perform any work on the steam system (including the steam lines, steam distributors, etc.) while the humidifier is operating. Shut down the Nortec EL steam humidifier, as described in ["Shutting Down" on page 62](#) before fixing any leaks in the steam system.

**WARNING!****Risk of severe burns from contact with hot surfaces!**

Components of the steam system (including the steam cylinder, steam distributors, etc.) get up to 212°F (100°C) during operation. Contact with the hot surfaces can result in severe burns.

**Prevention:** Shut down the Nortec EL steam humidifier as described in ["Shutting Down" on page 62](#) and wait for the components to cool down before performing any work on the steam system.

**CAUTION!****Risk of damage to internal components from electrostatic discharge (ESD)!**

The electronic components inside the humidifier are sensitive to electrostatic discharge (ESD).

**Prevention:** Take appropriate measures to protect the electronic components inside the unit against damage caused by electrostatic discharge (ESD). Refer to ANSI/ESD-S20.20.

**Preventing Unsafe Operation**

If it is suspected that the Nortec EL steam humidifier cannot be operated safely for any of the reasons listed below, shut it down immediately, as described in ["Shutting Down" on page 62](#), and secure it against accidental power-up.

- Humidifier is damaged
- Electrical connections are loose or damaged
- Humidifier is not operating properly
- Leaks in the steam system

All personnel working with the Nortec EL steam humidifier must immediately report to the customer any alternations to the humidifier that may affect safety.

**Modifications Prohibited**

**Modifications are not permitted** on the Nortec EL steam humidifier without the express written consent of Condair.

Always use **original Condair replacement parts and accessories** available through your local Condair representative.



# 3 Product Overview

## 3.1 General Description

The Nortec EL steam humidifier is an atmospheric steam generator, which operates on the electrode heating principle. It is designed for direct room humidification using a blower pack, or humidification through the ducts in an air handling unit using a steam distributor.

The Nortec EL steam humidifier has state-of-the-art features. It has an integrated control board which not only controls the humidifier, but also allows the humidifier to be connected to a building automation system (BACnet, Lonworks, Modbus) or the internet so it can be controlled and monitored remotely. In addition, up to six humidifiers (12 cylinders) can be set up in a main-extension configuration using Condair's Linkup system to satisfy large humidification needs.

The Nortec EL steam humidifier comes in three different housing sizes – small, medium and large. The small and medium size models have a single steam cylinder, while the large model is equipped with dual steam cylinders. Each steam cylinder has its own dedicated driver board to receive control signal inputs. The dual driver boards allow the large models to be configured to operate in series, in parallel or independent mode to control humidity in one or more zones depending on how they are configured.

Figure 1 shows the various components of the Nortec EL steam humidifier (door panels removed for clarity).

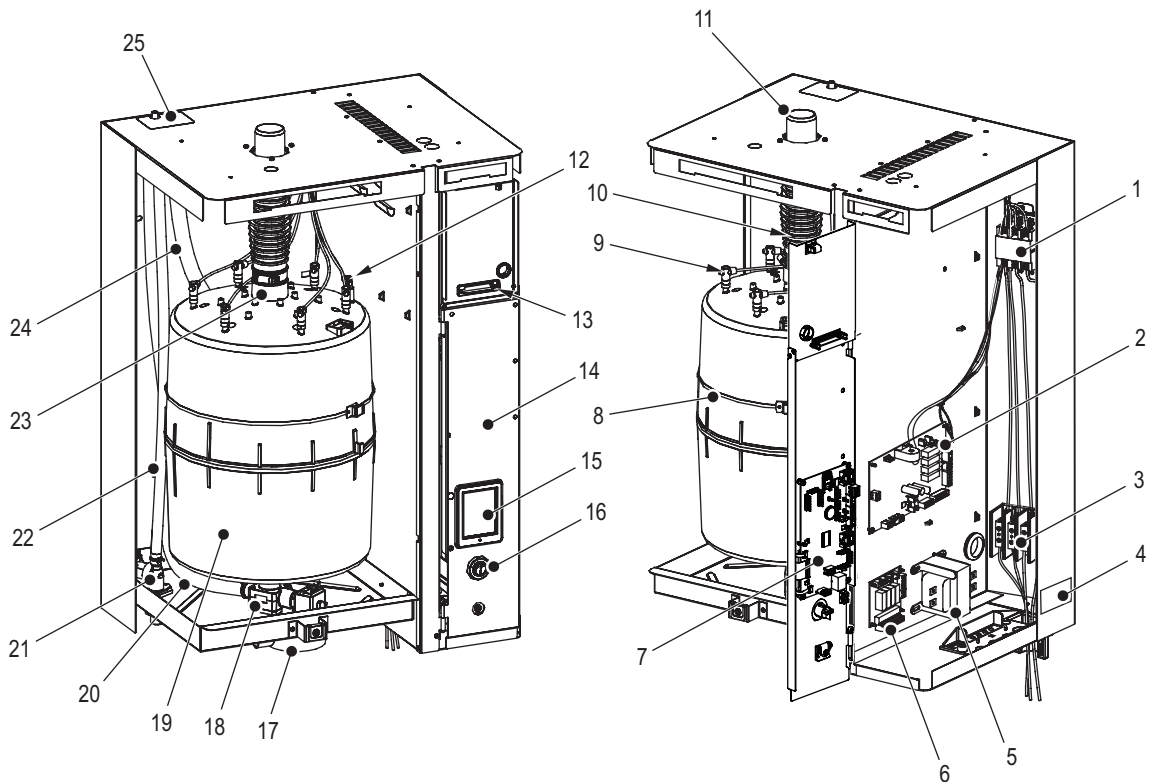

Figure 1: Nortec EL Steam Humidifier (Medium size model shown)

- |    |  |    |                                    |
|----|--|----|------------------------------------|
| 1  | Main contactor, K1                     | 14 | Front panel                        |
| 2  | Driver board                           | 15 | Touchscreen display                |
| 3  | Terminal block, high voltage supply    | 16 | On/Off switch                      |
| 4  | Specification label                    | 17 | Drain canal                        |
| 5  | Transformer                            | 18 | Drain valve                        |
| 6  | Remote fault indication PCB            | 19 | Steam cylinder                     |
| 7  | Integrated control board               | 20 | Fill hose (fill cup to cylinder)   |
| 8  | Cylinder strap                         | 21 | Fill valve                         |
| 9  | Electrode plug                         | 22 | Fill hose (fill valve to fill cup) |
| 10 | Steam outlet hose (optional)           | 23 | Steam outlet, steam cylinder       |
| 11 | Steam adaptor (optional)               | 24 | Overflow hose                      |
| 12 | Sensor, high water level (orange wire) | 25 | Fill cup                           |
| 13 | Low voltage terminal                   |    |                                    |

## 3.2 Functional Description

Refer to [Figure 1 on page 9](#) and [Figure 2 on page 11](#).

### Water Supply

Water enters the humidifier through the fill valve into the open fill cup with integral air gap, and then flows down through the fill hose into the steam cylinder.

### Steam Generation

When the humidifier receives a signal to supply steam the contactor closes, and after a 60 second delay the fill valve opens and water enters the bottom of the steam cylinder, as described above.

As soon as the electrodes come in contact with the water, current begins to flow between the electrodes, generating heat. As the water level continues to rise, more surface of the electrodes come in contact with the water. This results in more current draw. Once the water has heated to the boiling point, steam will be produced. (**Note:** On first startup when the conductivity level of the water is low, it may take 30-60 minutes for water to heat sufficiently to produce steam).

When the steam output reaches the requested level, the fill valve closes. As water is evaporated, the water level and current drop. When the current falls below a certain percentage of the requested level, the fill valve opens to raise the water level and the current and maintain the required steam output level.

When the actual output is higher than the requested steam output, the fill valve remains closed until the desired output level is achieved through a gradual lowering of the water level due to evaporation.

### Water Level Monitoring

A sensor monitors the high water level in the steam cylinder. When the sensor detects the high water level, the fill valve closes to prevent over-filling.

### Drainage

As the evaporation process continues, the conductivity level of the water increases due to the increasing levels of residual minerals left behind as the water turns into steam. This affects the current draw, which can rise beyond optimal levels. To prevent this from happening, the Nortec EL's auto-adaptive control algorithm periodically drains some concentrated water in the cylinder and replaces it with fresh water.

### Control

Steam production can be controlled using the continuous proportional (P) or the proportional-integral (PI) controller internal to the humidifier, or an external modulating controller, or with an On/Off control signal from an external humidistat.

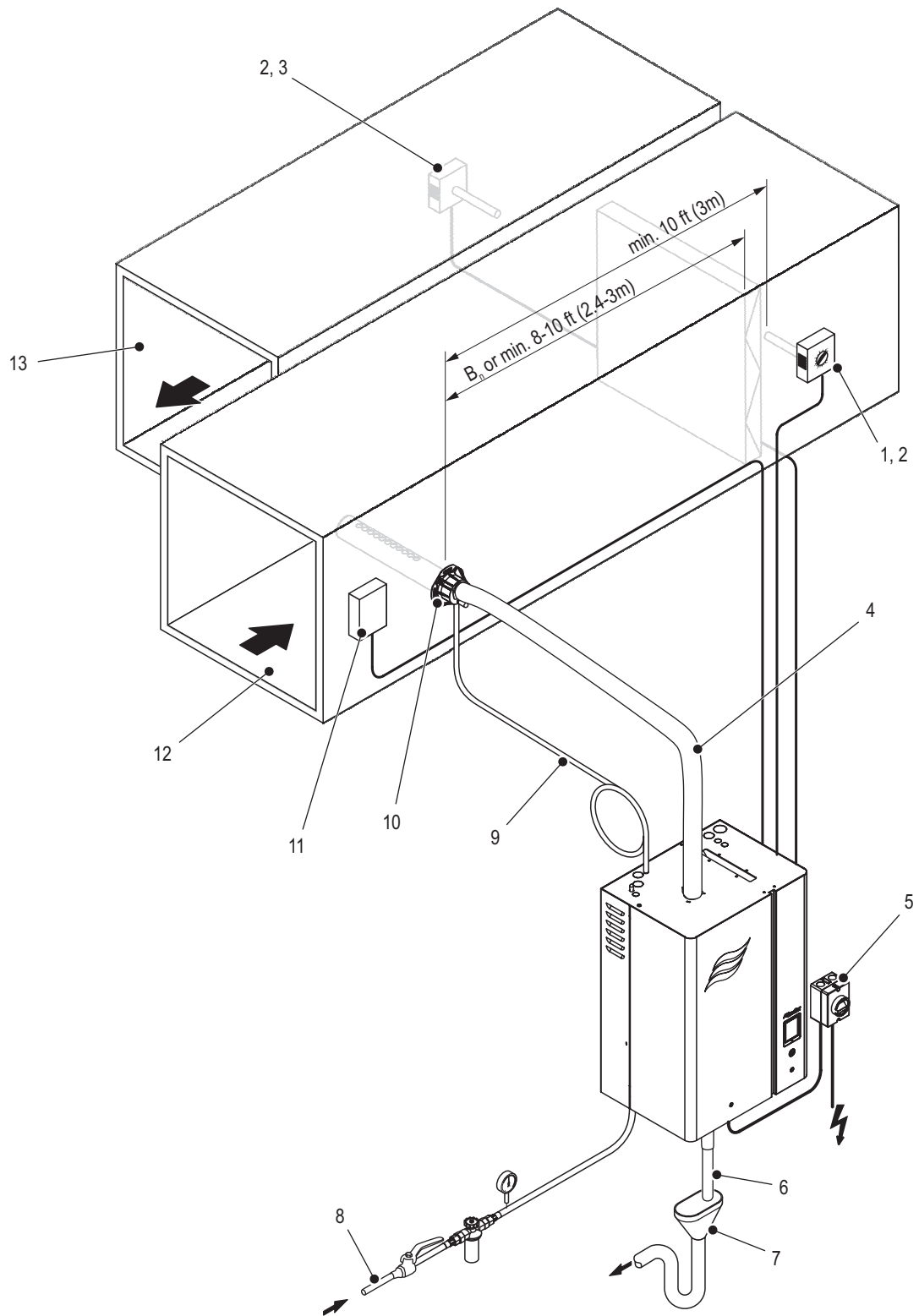
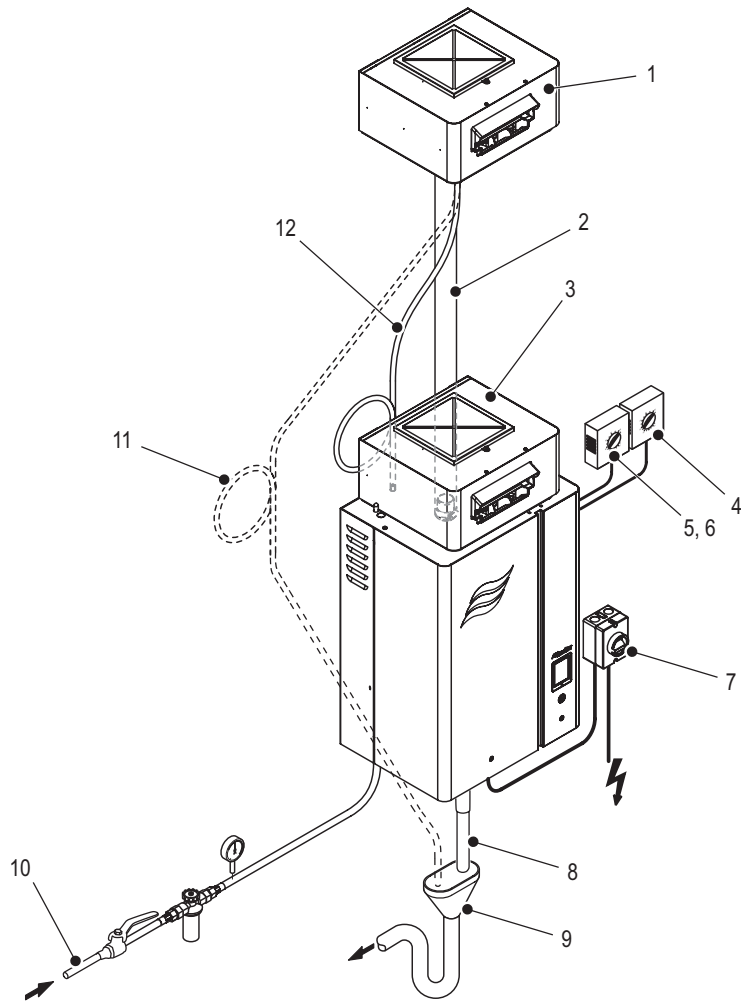

Figure 2: Nortec EL Duct Humidification

- |   |   |    |  |
|---|---|----|--|
| 1 | High limit On/Off humidistat (external safety chain)  | 8  | Water supply                               |
| 2 | Humidity sensor or modulating humidistat (used for control of space in return duct, or high limit in supply duct) | 9  | Condensate line                            |
| 3 | On/Off humidistat (used for humidity control)   | 10 | Steam distributor                          |
| 4 | Steam line  | 11 | Air proving switch (external safety chain) |
| 5 | Electrical disconnect, high voltage supply  | 12 | Supply air duct                            |
| 6 | Drain line  | 13 | Return air duct                            |
| 7 | Air gap with optional trap  |    |  |



*Figure 3: Nortec EL Direct Room Humidification*

- 1 Blower pack, remote-mounted
- 2 Steam line
- 3 Blower pack, built-on
- 4 High level On/Off humidistat (external safety chain)
- 5 Humidity sensor or humidistat (used for control of space humidity or high limit)
- 6 On/Off humidity control
- 7 Electrical disconnect, high voltage supply
- 8 Drain line
- 9 Air gap with optional trap
- 10 Water supply
- 11 Condensate drain line (routed to floor drain)
- 12 Condensate drain connection through fill cup to steam cylinder (for remote blower pack)

# 4 Operator Interface

## 4.1 Controls

The operator interface in the Nortec EL steam humidifier is located on the front of the unit – refer to [Figure 4](#). It consists of a touchscreen display with a LED status indicator, and an On/Off switch. Refer to [Table 1 on page 14](#) for a description of each of these elements.

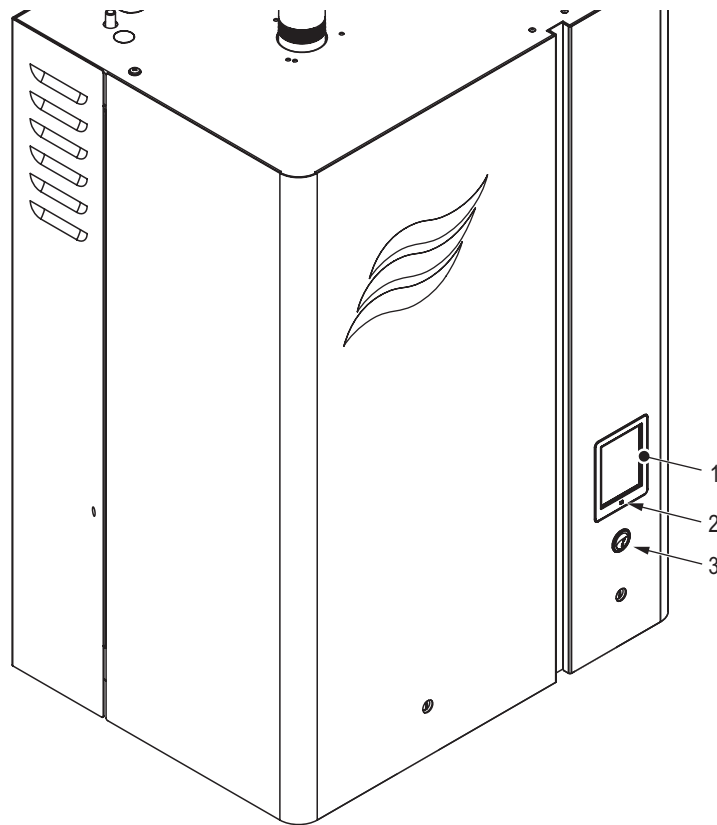

Figure 4: Nortec EL Operator Interface

- 1 Touchscreen display
- 2 LED status indicator
- 3 On/Off switch



**DANGER!**  
Risk of electric shock!

**The control cabinet in the Nortec EL steam humidifier has live voltage. Turning off the unit at the On/Off switch does not shut off power to the control cabinet. Touching live parts may cause severe injury or even death.**

**Prevention:** Shut down the humidifier properly as described in ["Shutting Down" on page 62](#) before accessing the control cabinet in the humidifier.

Table 1: Operator Interface Element Functions

Element	Description
Touchscreen display	Allows the user to monitor or control the Nortec EL humidifier. Refer to <a href="#">"Control Software" on page 15</a> for details of the software interface.
LED status indicator	<p>The status LED is a multi-function LED, which lights up in different colors depending on the operating status of the humidifier.</p> <p>Green: indicates that the Nortec EL is operating normally and humidifying.</p> <p>Flashing Green: indicates that the Nortec EL is in standby mode.</p> <p>Yellow: indicates that a warning condition is present, or the humidifier is due for maintenance.</p> <p>Red: indicates that a fault condition is present, and humidification is stopped. <b>Note:</b> On units with a dual steam cylinders, it indicates that a fault condition exists in one or both steam cylinders, and humidification is stopped in the steam cylinder(s) with the fault condition.</p>
On/Off switch	Allows the user to turn the Nortec EL humidifier on or off.

## 4.2 Control Software

The control software runs in the background and controls all the functions of the Nortec EL steam humidifier. The user interacts with the control software through the screens on the touchscreen display. Details of the screens are described in the sections below.

**Note:** The screens shown in this chapter are for representation purposes only, and may differ from what is displayed on your humidifier.

### 4.2.1 Home Screen

When the Nortec EL steam humidifier is turned on, it starts initializing and performs system checks. When initialization and system checks are completed successfully, it goes into the normal operating mode. The Home screen then appears on the touchscreen display.

The major elements of the Home screen are shown in [Figure 5](#).

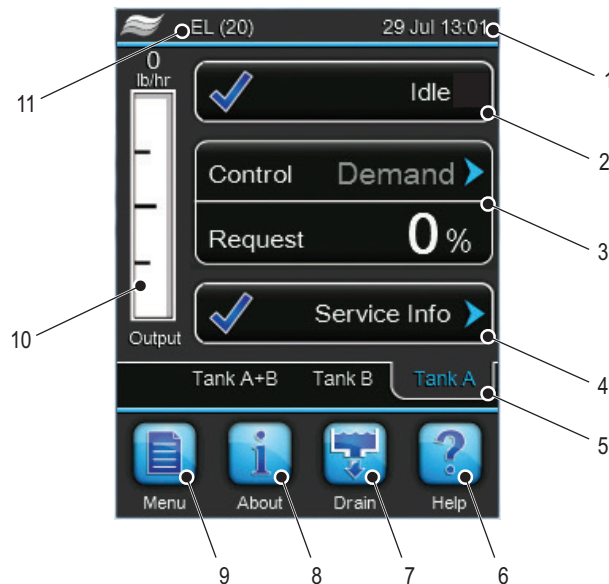

*Figure 5: Home Screen Elements*

- 1 Current date and time
- 2 Operating status message – refer to ["Operating Status" on page 16](#) for details.
- 3 Humidity control information – shows the type of control signal and the steam output requested.
- 4 Service/Warning/Fault status message – refer to ["Maintenance and Fault Status" on page 17](#) for details.
- 5 **Steam Cylinder** selector. Only available on units with dual steam cylinders, and units controlled by the Linkup system. Select the appropriate tab to view its status on the Home screen.
- 6 **<Help>** button – access technical support help information. Refer to ["Help" on page 18](#) for details.
- 7 **<Drain>** button – manually initiate the drain function. Refer to ["Manually Initiate Steam Cylinder Draining" on page 59](#) for details.
- 8 **<About>** button – access the system information. Refer to ["System Information" on page 18](#) for details.
- 9 **<Menu>** button – access the Main menu. Refer to ["Main Menu" on page 25](#) for details.
- 10 Visual indication of the current steam output level.
- 11 Condair humidifier model number

## 4.2.2 General Navigational Elements

Figure 6 show the general navigational elements/features of the screens on the touchscreen display.

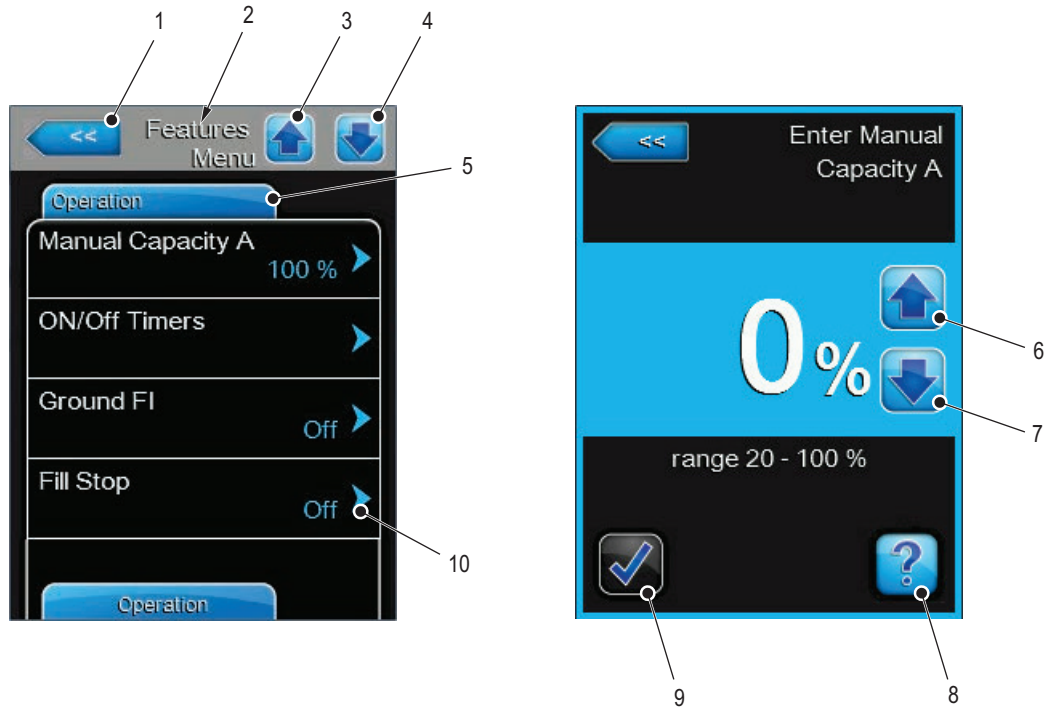

Figure 6: General Navigational Elements

- 1 **Return** button – cancel and return to previous menu level.
- 2 Current menu/sub-menu selection
- 3 **Previous Tab** button – return to the previous tab in the current menu/sub-menu selection.
- 4 **Next Tab** button – continue/go to the current/next tab in the menu/sub-menu selection.
- 5 Current tab
- 6 **Increase** button – increase the setpoint value.
- 7 **Decrease** button – decrease the setpoint value.
- 8 **Help** button – access context-sensitive help.
- 9 **Confirm** button – confirm the change/selection. Changes will not be stored if this button is not pressed.
- 10 Additional information icon – access additional information.

## 4.2.3 Operating Status

The operating status area of the Home screen (refer to Figure 5) shows the current operating status message and an associated status icon. The messages are described in Table 2, and the status icons are described in Table 3 on page 17.



Table 2: Operating Status Descriptions

Message	Description
Standby	The humidifier is in standby mode (no humidity demand).
Draining	The humidifier is draining the steam cylinder.
Idle Drain	There has been no demand for humidity for an extended period of time. The <i>idle drain</i> function has drained the humidifier. The humidifier will automatically refill when it receives a humidity demand.
Partial Drain	There has been no demand for humidity for an extended period of time. The <i>partial drain</i> function has drained the water off of the electrodes.
Humidifying	The humidifier is generating steam.



Message	Description
Keep Warm	The humidifier is in standby mode, and the <i>keep warm</i> function is activated.
Disabled	The Nortec EL humidifier is disabled by the BMS (building management system).
Stopped	The humidifier is stopped because a condition with a "Fault" status is active.
Safety Loop	One or more contacts in the external safety loop is open, so the humidifier has stopped producing steam.
Blower Pack	The blower pack input signal to the humidifier is open. The humidifier will not produce steam.
Warning	A condition with a "Warning" status is active. In addition, the message "Warning" is shown in the maintenance/fault status area of the Home screen. The humidifier will continue to produce steam when there is a demand (unless the warning relates to a control signal).
Fault	A condition with a "Fault" status is active. The humidifier is stopped. In addition, the message "Fault" is shown in the maintenance/fault status area of the Home screen.

Table 3: Status Icon Descriptions

Icon	Description
	The icon appears to the left of the operating status message or the maintenance/fault message when the system is working normally.
	The icon appears to the left of the maintenance/fault status message when a maintenance reminder or a condition with a "Warning" status is active. The humidifier will continue to produce steam when there is a demand (unless the warning relates to a control signal).
	The icon shown appears to the left of the maintenance/fault status message when a condition with a "Fault" status is active. The humidifier stops producing steam.

#### 4.2.4 Maintenance and Fault Status

The Service/Warning/Fault status area of the Home screen (refer to [Figure 5 on page 15](#)) shows maintenance reminders, maintenance and fault status messages along with associated status icons. This field also allows access to the ["Service Menu"](#). When a maintenance reminder, warning or fault status message is active, the Fault History list can be accessed directly from this field to view additional details.

The general maintenance reminders and alarm messages displayed in this area are described in [Table 4](#), and the status icons are described in [Table 3](#). Refer to ["Warning and Fault List" on page 78](#) for a detailed list of warning and fault messages.

Table 4: Maintenance/Fault Status Descriptions

Message	Description
Service info	No faults conditions present.
Cylinder Spent	This message appears if the control software has detected that the steam cylinder is filled with scale and can no longer achieve the required output. If the steam cylinder is not replaced, and the maintenance cylinder is not reset within 72 hours (run time), a corresponding fault message appears. Replace the steam cylinder, then reset the maintenance cylinder in the Service menu. Refer to <a href="#">"Removal and Installation of Steam Cylinder" on page 66</a> .

Message	Description
Warning	A condition with a "Warning" status is active. Depending on the warning condition, the Nortec EL humidifier will continue to produce steam when there is a demand (unless the warning relates to a control signal). In addition, the status LED turns yellow in color.
Fault	A condition with a "Fault" status is active. Depending on the fault condition, the Nortec EL humidifier will not produce steam until the fault condition is cleared. In addition, the status LED turns red in color.

## 4.2.5 Help

Touch the **<Help>** button on the Home screen (refer to [Figure 5 on page 15](#)) to view your local technical support help details.

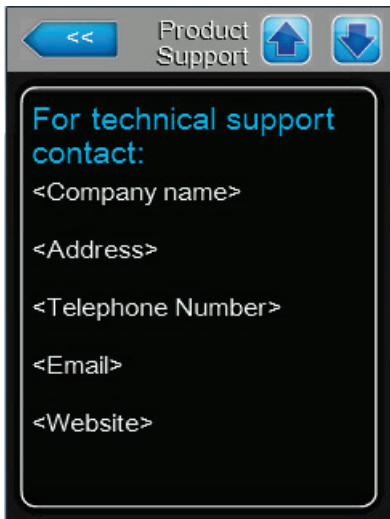

## 4.2.6 System Information

Select the **<About>** button on the Home screen (refer to [Figure 5 on page 15](#)) to view the system information for your Nortec EL steam humidifier. The tab structure for this selection is shown below.

- About > ["General Tab" on page 19](#)
- ["Timer Cylinder A \(Timer Cylinder B\) Tab" on page 20](#)
- ["Service Cylinder A \(Service Cylinder B\) Tab" on page 20](#)
- ["Operating Cylinder A Tab" on page 20](#)
- ["Operating Cylinder B Tab" on page 22](#)
- ["Features Tab" on page 23](#)
- ["Network Tab" on page 24](#)

## General Tab

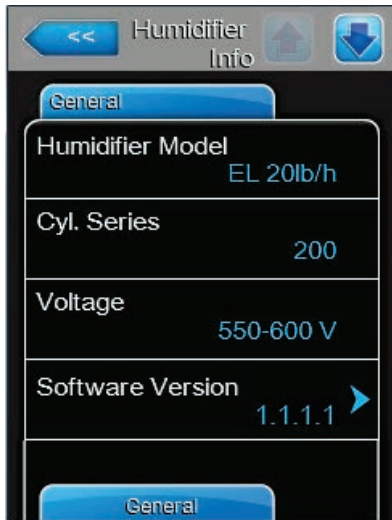

- **Humidifier Model:** shows the model number, as also seen on the specification label (on the underside and right side of the humidifier).
- **Cyl. Series:** shows the cylinder series used in the humidifier.
- **Voltage:** shows the rated heating voltage of the humidifier.
- **Software Version:** shows the current version of the control software. Select the field to update the control software or the driver board firmware – refer to ["Software Update Tab" on page 53](#) for details.



- **Serial Number:** shows the serial number, as also seen on the specification label.
- **Graph:** allows you to view a graphical presentation of the recent humidifier performance.
- **Export Trend Data:** allows you to save the performance data as a .csv file to a USB memory stick. Refer to ["Exporting Trend Data" on page 60](#).  
**Note:** Insert a USB memory stick (formatted to 32-bit FAT system) into the USB port on the control board before selecting this function.

### Timer Cylinder A (Timer Cylinder B) Tab



**Note:** The Timer Cylinder B tab appears only on units with dual steam cylinders that are set to work in independent mode. It is identical to the Timer Cylinder A tab.

- **On/Off Timers:** shows the current status of the On/Off timers function. Refer to [On/Off Timers](#) for more details. **Note:** A warning message is displayed whenever the humidifier is turned off by the On/Off timer.
- **Capacity Timers:** shows the current status of the capacity limitation timer function. Refer to [Capacity Timers](#) for more details.
- **Setpoint Timers:** shows the current status of the setpoint timers function. Refer to [Setpoint Timers](#) for more details. **Note:** This field only appears if [Control Mode](#) is set to "RH P" or "RH PI".

### Service Cylinder A (Service Cylinder B) Tab

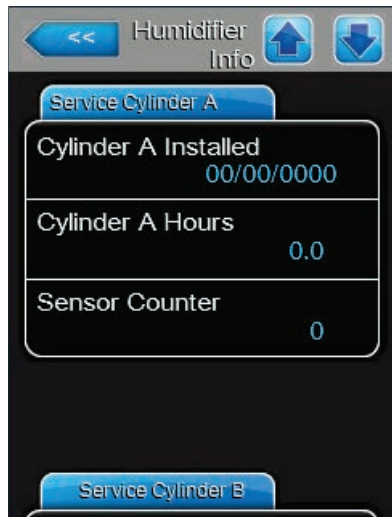

**Note:** The Service Cylinder B tab appears only on units with dual steam cylinders, and is identical to the Service Cylinder A tab.

- **Cylinder A Installed:** shows the date of installation of the steam cylinder.
- **Cylinder A Hours:** shows the number of operating hours on the steam cylinder since its installation.
- **Sensor Counter:** shows the number the number of high water level sensor activations. A high sensor counter value may indicate the cylinder is nearing end of life or that a newly installed cylinder is concentrating cylinder water to optimal level.

### Operating Cylinder A Tab

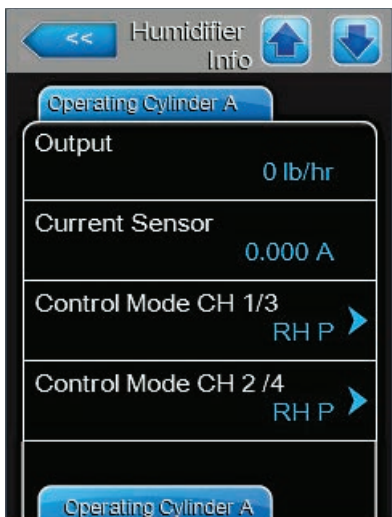

- **Output:** shows the actual output level of steam cylinder A.
- **Current Sensor:** shows the actual current draw (in amperes) by steam cylinder A.
- **Control Mode CH 1/3:** shows the general control mode setting for the control signals to the humidifier. Select the field to choose a different control mode – "Demand", "RH P", "RH PI" or "On/Off". Refer to [Control Mode](#) for more details.
- **Control Mode CH 2/4:** shows the general control mode setting for the high limit input signal to the humidifier. Select the field to choose a different control mode – "Demand", "RH P", "RH PI" or "On/Off". Refer to [Control Mode](#) for more details. **Note:** This field only appears if [Control Channels](#) is set to "Dual".

Operating Cylinder A Tab, continued...



- **Channel 1:** shows the input signal for Channel 1. If configured for demand control, it represents the demand. If configured for RH(P/PI), it represents sensed humidity.
- **Setpoint Channel 1:** shows the fixed humidity setpoint value for steam cylinder A. Select the field to adjust the setpoint value. Refer to "[Setpoint Tab](#)" on page 36 for more details.  
**Note:** This field appears only if the [Control Mode](#) is set to "RH P" or "RH PI".
- **Channel 2:** shows the input signal for Channel 2. If configured for demand control, it represents the demand. If configured for RH(P/PI), it represents sensed humidity.  
**Note:** This field appears only if [Control Channels](#) is set to "Dual".
- **Setpoint Channel 2:** shows the high limit setpoint value for steam cylinder A. Select the field to adjust the value.  
**Note:** This field appears only if the [Control Mode](#) is set to "RH P" or "RH PI", and [Control Channels](#) is set to "Dual".

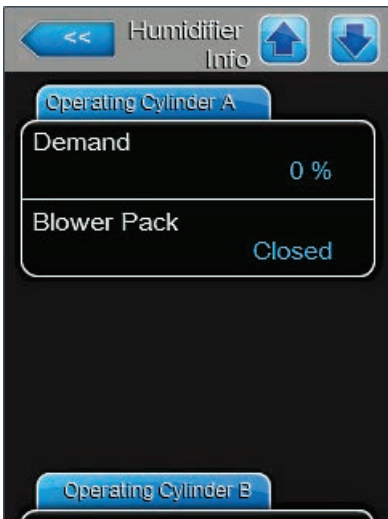

- **Demand:** shows the demand the control software has calculated for steam cylinder A, as a percentage of maximum capacity.
- **Blower Pack:** shows the status of the blower pack security loop – "Closed" when the blower pack is connected and powered, and "Open" when it is not.  
**Note:** When a blower pack is not connected, a jumper must be installed in the blower pack security loop, and the status should display "Closed".

## Operating Cylinder B Tab

**Note:** The Operating Cylinder B tab appears only on units with dual steam cylinders.

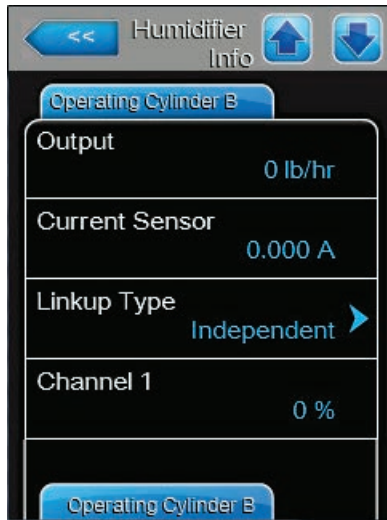

- **Output:** shows the actual output of steam cylinder B.
- **Current Sensor:** shows the actual current draw (in amperes) by steam cylinder B.
- **Linkup Type:** shows the current mode of operation of the steam cylinder in the Linkup chain. Select the field to choose a different mode – "Series", "Parallel" or "Independent". Refer to [Linkup Type](#) for more details.
- **Channel 1:** shows the input signal for Channel 1 of Cylinder B.  
**Note:** This field is only displayed if [Dual Cylinder Mode](#) is set to "Independent". If configured for demand control, it represents the demand. If configured for RH(P/PI), it represents sensed humidity.



- **Setpoint Channel 1:** shows the fixed humidity setpoint value for steam cylinder B. Select the field to adjust the value. Refer to ["Setpoint Tab" on page 36](#) for more details.  
**Note:** This field appears only if the [Control Mode](#) is set to "RH P" or "RH PI", and [Dual Cylinder Mode](#) is set to "Independent".
- **Channel 2:** shows the input signal for Channel 2 of Cylinder B.  
**Note:** This field is only displayed if [Dual Cylinder Mode](#) is set to "Independent" and [Control Channels](#) is set to "Dual". If configured for demand control, it represents the demand. If configured for RH(P/PI), it represents sensed humidity.
- **Setpoint Channel 2:** shows the high limit setpoint value for steam cylinder B. Select the field to adjust the value.  
**Note:** This field appears only if the [Control Mode](#) is set to "RH P" or "RH PI", and [Dual Cylinder Mode](#) is set to "Independent" and [Control Channels](#) is set to "Dual".
- **Demand:** shows the demand the control software has calculated for steam cylinder B, as a percentage of maximum capacity.
- **Blower Pack:** shows the status of the blower pack security loop for cylinder B – "Closed" when the blower pack is connected and powered, and "Open" when it is not.  
**Note:** When a blower pack is not connected, a jumper must be installed in the blower pack security loop, and the status should display "Closed".

## Features Tab

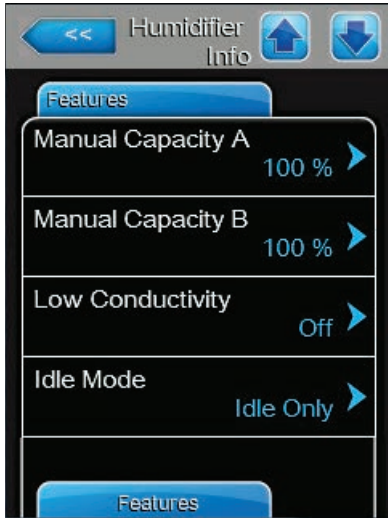

- **Manual Capacity A:** shows the set capacity limitation value as a percentage of the maximum capacity of steam cylinder A. Select the field to adjust the value. Refer to ["Manual Capacity Tab" on page 29](#) for more details.
- **Manual Capacity B:** shows the set capacity limitation value as a percentage of the maximum capacity of steam cylinder B. Select the field to adjust the value.  
**Note:** This field appears only on units with dual steam cylinders.
- **Low Conductivity:** shows the status of the low conductivity function. Select the field to enable or disable the function. Refer to [Low Conductivity](#) for more details.
- **Idle Mode:** shows the idle function that is active when the humidifier is in standby mode. Select the field to choose a different function – "Idle Only", "Idle Drain", "Keep Warm", or "Partial Drain". Refer to [Idle Mode](#) for more details.



- **Forced Drain:** shows the status of the forced drain function. Select the field to enable or disable the function. Refer to [Forced Drain](#) for more details.
- **Forced Drain Interval:** shows the number of run hours after which the forced drain function is triggered. Select the field to change the time interval. Refer to [Forced Drain Interval](#) for more details.
- **Short Cycle:** shows the status of the short cycle function. Select the field to enable or disable the function. Refer to [Short Cycle](#) for more details.

## Network Tab

The information shown in this tab varies depending on whether a BAS (building automation system) protocol is on, and which protocol is selected. If no BAS protocol is on, then only Online Status and IP Address are shown.

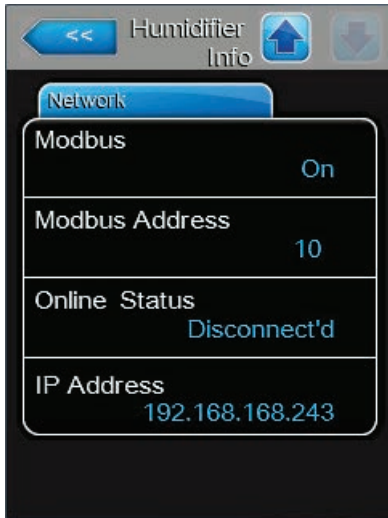

### Modbus Network

- **Modbus:** shows the current status of the Modbus communications protocol.  
**Note:** This field appears only if the Modbus communication protocol is enabled. Refer to [Modbus](#) for more details.
- **Modbus Address:** shows the Modbus address of the Nortec EL steam humidifier.  
**Note:** This field appears only if the [Modbus](#) communication protocol is enabled, and the [BACnet](#) communication protocol is disabled.

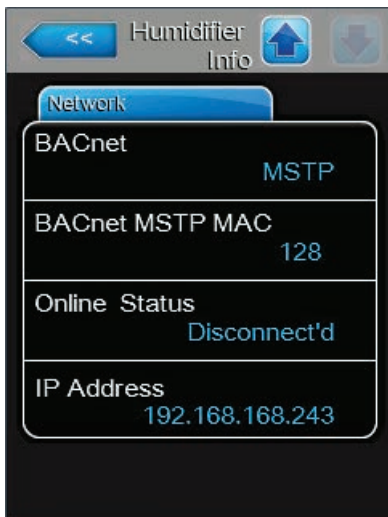

### BACnet Network

- **BACnet:** shows the current selection for the BACnet communication protocol – "MSTP" or "BACnet/IP".  
**Note:** This field appears only if the BACnet communication protocol is enabled. Refer to [BACnet](#) for more details.

### BACnet MSTP Network

- **BACnet MSTP MAC:** shows the actual BACnet MSTP MAC address for the Nortec EL steam humidifier.  
**Note:** This field appears only if "BACnet MSTP" is enabled. Refer to [BACnet](#) for more details.



### BACnet IP Network

- **Node ID:** shows the actual BACnet node ID for the Nortec EL steam humidifier.  
**Note:** This field appears only if "BACnet IP" is enabled. Refer to [BACnet](#) for more details.
- **IP Address:** shows the IP address of the Nortec EL steam humidifier.



## 4.2.7 Main Menu

Select the **<Menu>** button on the Home screen to view the Main menu. The Main menu and its contents are password-protected. Refer to [Figure 7](#). Enter the password "0335" to access the Main menu.

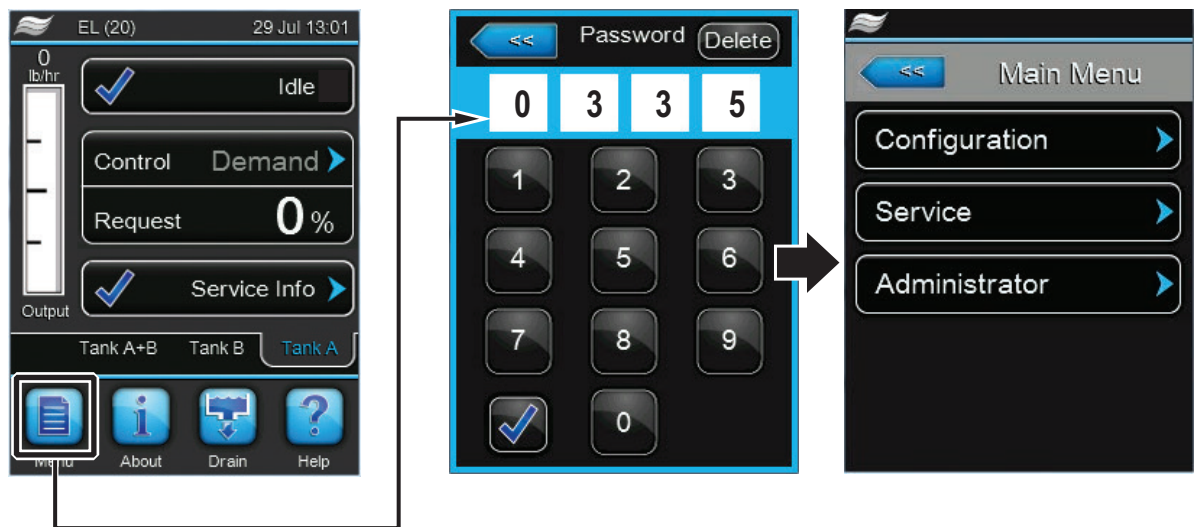

Figure 7: Main Menu Access

To access the Configuration menu and its features, refer to ["Configuration Menu" on page 27](#).

To access the Service menu and its features, refer to ["Service Menu" on page 48](#).

To access the Administrator menu and its features, refer to ["Administrator Menu" on page 52](#).

The structure of the Main menu and its sub-menus is shown in [Table 5](#).

**Table 5: Main Menu Structure**

<a href="#">"Main Menu" on page 25 &gt;</a>	<a href="#">"Configuration Menu" on page 27 &gt;</a>	<a href="#">"Features Menu" on page 27 &gt;</a>	<a href="#">"Water Management Tab" on page 27</a>	
			<a href="#">"Operation Tab" on page 29 &gt;</a>	<a href="#">"Manual Capacity Tab" on page 29</a>
			<a href="#">"Accessory Board Tab" on page 32</a>	
		<a href="#">"Control Settings Menu" on page 33 &gt;</a>	<a href="#">"Basic Tab" on page 33</a>	
			<a href="#">"PI Control Parameters (A and B) Tab" on page 36</a>	<a href="#">"Setpoint Tab" on page 36</a>
			<a href="#">"RH Alerts Tab" on page 38</a>	
			<a href="#">"Multi-Unit Operation Tab" on page 39</a>	
		<a href="#">"General Menu" on page 41 &gt;</a>	<a href="#">"Basic Tab" on page 41</a>	
			<a href="#">"Time/Date Tab" on page 42</a>	
		<a href="#">"Communication Menu" on page 43 &gt;</a>	<a href="#">"Remote Enable Tab" on page 43</a>	
	<a href="#">"Network Parameters Tab" on page 43</a>			
	<a href="#">"BMS Timeout Tab" on page 44</a>			
	<a href="#">"Modbus Parameters Tab" on page 45</a>			
	<a href="#">"BACnet Parameters Tab" on page 45</a>			
	<a href="#">"Remote Fault Board Tab" on page 47</a>			
	<a href="#">"Service Menu" on page 48 &gt;</a>	<a href="#">"Startup Code Tab" on page 48</a>		
		<a href="#">"General Service Tab" on page 48</a>		
		<a href="#">"Fault/Service History Tab" on page 49</a>		
		<a href="#">"Diagnostics Tab" on page 50 &gt;</a>	<a href="#">Input Diagnostics tab &gt;</a>	<a href="#">"Cylinder (A and B) Tab" on page 50</a>
			<a href="#">Relay Diagnostics tab &gt;</a>	<a href="#">"Remote Fault Board Tab" on page 51</a>
<a href="#">"Administrator Menu" on page 52 &gt;</a>		<a href="#">"Accessory Board Tab" on page 51</a>		
	<a href="#">"Password Setting Tab" on page 52</a>			
	<a href="#">"Software Update Tab" on page 53</a>			
	<a href="#">"Software Settings Tab" on page 53</a>			

### 4.2.7.1 Configuration Menu

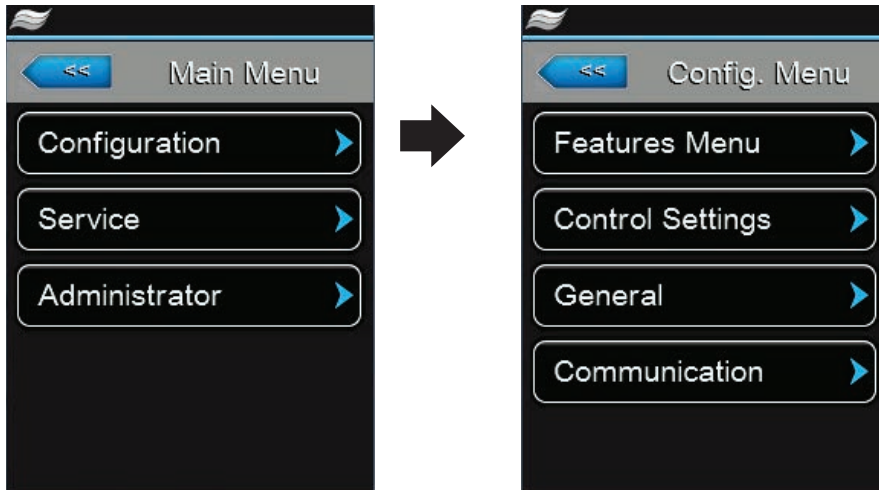

The Configuration menu lets you configure the operation of the Nortec EL steam humidifier. The menu and sub-menu items are discussed below. Refer to [Table 5 on page 26](#) for the menu structure.

#### Features Menu

Each tab under the Features Menu is discussed below.

#### Water Management Tab



- **Drain Cool:** allows you to enable or disable the optional drain water cooling function.  
Options: *On or Off*  
Factory setting: *On*
- **Idle Mode:** allows you to set the idle function of the humidifier when it is in standby mode.  
Options: *Idle Only* – the humidifier waits indefinitely for a demand signal.  
*Idle Drain* – the steam cylinder is drained after Idle Drain time passes without demand.  
*Keep Warm* – the water in the steam cylinder is kept warm while in standby mode.  
*Partial Drain* – the steam cylinder is drained until water is below the electrodes after *Idle Drain* time passes without a demand.  
Factory setting: *Idle Only*
- **Idle Drain Time:** allows you to set the time duration the humidifier stays in standby mode without a demand, after which the humidifier carries out the function specified in [Idle Mode](#).  
Setting range: *1-100 hours*  
Factory setting: *72 hours*

Water Management Tab, continued...

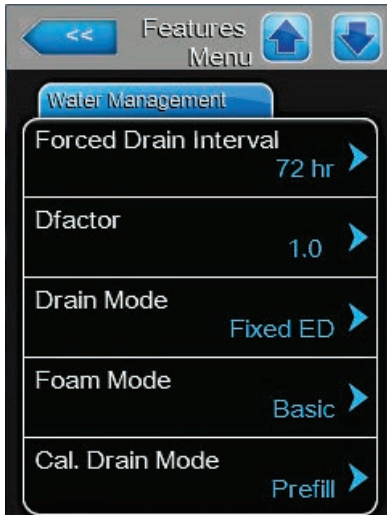

- **Forced Drain:** allows you to enable or disable the forced drain function, which drains the steam cylinder to remove minerals every time a fixed number of run hours passes. It can be useful when operating with water that has high conductivity.  
Options: *On or Off*  
Factory setting: *Off*
- **Forced Drain Interval:** allows you to set the number of run hours after which a forced cylinder drain takes place.  
Setting range: *1-100 hours*  
Factory setting: *72 hours*
- **D(rain) Factor:** allows you to adjust the drain time calculated by the Nortec EL's auto-adaptive drain algorithm.  
Setting range: *0.0-100.0*  
Factory setting: *1.0*
- **Drain Mode:** allows you to select when the humidifier will perform a drain because current draw exceeds requirements. **Note:** Float ED can respond more quickly to drops in demand.  
Options: *Fixed ED* – corrective drain occurs when current draw exceeds 115% of full steam capacity.  
*Float ED* – corrective drain occurs when current draw exceeds 115% of steam demand.  
Factory setting: *Fixed ED*
- **Foam Mode:** allows you to select the foam detection function in the steam cylinder. The humidifier will perform drains to attempt to eliminate foaming, if it is detected.  
Options: *Basic* – detects foaming by monitoring current before and after the high water level sensor is activated.  
*Advanced* – detects foaming by using an external float. **Note:** This option requires the installation of an optional hardware kit.  
*Off* – performs no foam detection.  
Factory setting: *Basic*
- **Cal. Drain Mode:** allows you to select how the steam cylinder is drained in order to control conductivity of water in the cylinder. Both Prefill and Multi can prevent water from draining off the electrode when long drains are required.  
Options: *Prefill* – fills to a preset level first, then drains.  
*Basic* – drains for calculated drain time.  
*Multi* – performs multiple short drains and fills until the accumulated time of the short drains is equal to calculated drain time.  
Factory setting: *Prefill*

## Operation Tab



- **Manual Capacity A:** allows you to select the Manual Capacity menu, shown below. This menu allows you to set a fixed maximum output capacity, or set a time-dependant maximum output capacity using a timer function.

## Manual Capacity Tab

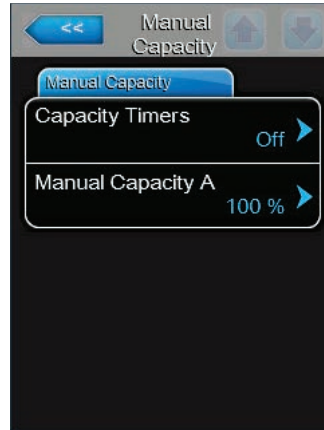

Allows you to set a fixed maximum output capacity without the use of timers.

- **Capacity Timers:** allow you to enable or disable the timer function, and configure up to eight different events with different output capacities.



**Timer:** allows you to enable or disable the Manual Capacity timer function to reduce maximum output during selected days and times of the day.

Options: *On* or *Off*

Factory setting: *Off*

**Event "n":** allows you to define a maximum output that will be allowed by: day of the week or over a range of days, the start time and capacity. "n" represents events 1-8. Each event can also be turned off individually.

**Note:** The settings for an event are active up to the next event. Check the timer settings make sense, as the software does not check the plausibility of the settings. At least two events must be set. The *On/Off timer* overrides the Capacity timer.

- **Manual Capacity A:** allows you to set a fixed maximum output capacity at the specified time and date.  
Setting range: *20-100%*  
Factory setting: *100%*

Operation Tab, continued...



- **On/Off Timers:** allow you to enable or disable the On/Off timer function to permit disabling of steam production during specified days and times.



**Timer:** allows you to enable or disable the On/Off timer function.

Options: *On or Off*

Factory setting: *Off*

**Event "n":** allows you to set whether the humidifier can or cannot produce steam by: day of the week or over a range of days, the start time and operating mode of the steam cylinder. "n" represents events 1-8. Each event can also be turned off individually.

**Note:** The settings for an event are active up to the next event. Check the timer settings make sense, as the software does not check the plausibility of the settings. At least two events must be set. The On/Off timer overrides the *Capacity timer* and *Setpoint timer*.

- **Ground FI:** allows you to set the main contactor to disengage whenever the drain valve is activated. This prevents current leakage to the drain, which could trip sensitive GFI circuitry in the building.

Options: *On* – the main contactor is disengaged during draining.

*Off* – the main contactor remains engaged if humidification is in progress.

Factory setting: *Off*

- **Fill Stop:** allows you to set the fill valve to close during filling (to prevent overshooting the demand) when the heating current draw equals 95% of the demand.

Options: *On* – the fill valve closes when the current draw equals 95% of demand.

*Off* – the fill valve remains open until 100% of the demand is achieved.

Factory setting: *Off*

Operation Tab, continued...



– **Overcurrent:**

---

**CAUTION!** Do not adjust this value unless instructed to do so by a Condair representative.

---

Setting range: 0.0-2.0

Factory setting: 1.5

- **Low Conductivity:** allows you to adjust the end-of-cylinder-life detection to prevent false end-of-cylinder-life detection when conductivity of the supply water is less than 250  $\mu\text{S}/\text{cm}$ .

Options:                    *On* – use when conductivity of the supply water is less than 250  $\mu\text{S}/\text{cm}$ .  
                                  *Off* – use when conductivity of the supply water is greater than 250  $\mu\text{S}/\text{cm}$ .

*Factory setting:*        *Off*

- **Short Cycle:** allows you to enable or disable the function that enforces a time delay between the humidifier stopping and restarting steam production (to reduce mechanical wear on contactors and other peripheral devices). This function is typically used with On/Off controllers. It can also be useful if a high limit humidistat is cycling the humidifier on/off too frequently.

Options:                    *On* – the humidifier runs in short cycle mode.  
                                  *Off* – the humidifier cycles normally.

*Factory setting:*        *Off*

## Accessory Board Tab

**Note:** This tab requires the optional accessory relay PCB (printed circuit board) be installed in your humidifier. The accessory relay PCB is used to control an external fan in the ventilation system, or an external valve for flushing the water supply line.

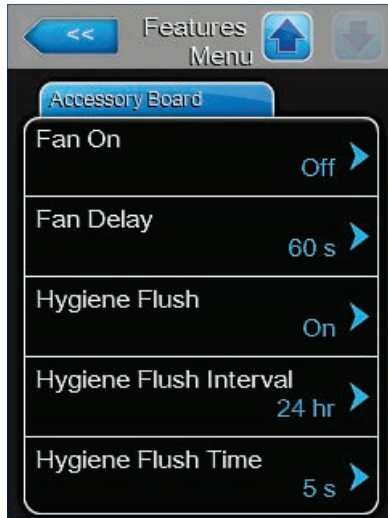

- **Fan On:** allows you to enable or disable the external fan connected to the corresponding relay on the accessory relay PCB.

Options:                    *On* – enables the relay.  
                                  *Off* – disables the relay.

Factory setting:        *Off*

- **Fan Delay:** allows you to set the time duration for which the external fan continues to run (to remove any additional steam that may have continued to enter the air duct post-humidification).

Setting range:            *0-300 seconds*

Factory setting:        *60 seconds*

- **Hygiene Flush:** allows you to enable or disable an external flushing valve connected to the corresponding relay on the accessory relay PCB. Flushing occurs only when the humidifier is in standby mode, according to the Hygiene Flush Interval and Hygiene Flush Time settings described below.

Options:                    *On* – performs hygiene flush at specified intervals.

*Off* – disables hygiene flush.

Factory setting:        *Off*

**Note:** The following two settings are only available if the hygiene flush function is enabled.

- **Hygiene Flush Interval:** allows you to set the time duration after which the water supply line is flushed.

Setting range:            *1-999 hours*

Factory setting:        *24 hours*

- **Hygiene Flush Time:** allows you to set the time duration of the flush.

Setting range:            *1-3600 seconds*

Factory setting:        *5 seconds*



## Control Settings Menu

Each tab under the Control Settings menu is discussed below. Refer to the structure of the tabs in [Table 5 on page 26](#).

### Basic Tab

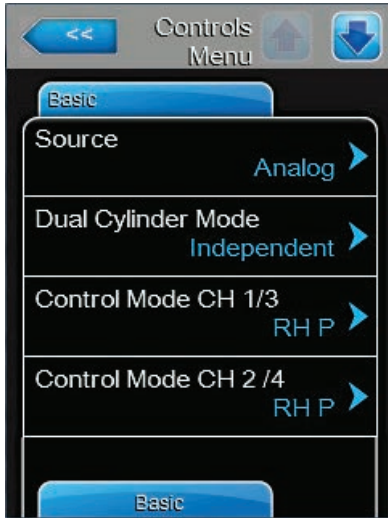

- **Source:** allows you to select the source of incoming control/humidity signal to the humidifier.

Options:

- Analog* – the control/humidity signals are from analog sensors or humidistats connected to the humidifier's low voltage terminal block.
- Modbus* – the control signals are from the BMS via the Modbus communication protocol.
- BACnet/IP* – the control signals are from the BMS via the BACnet/IP communication protocol.
- BACnet/MSTP* – the control signals are from the BMS via the BACnet/MSTP communication protocol.
- LonWorks* – the control signals are from the BMS via the LonWorks communication protocol.

Factory setting: *Analog*

- **Dual Cylinder Mode:** allows you to configure the operation of humidifiers with dual steam cylinders. **Note:** This function appears only on units with dual steam cylinders.

Options:

- Parallel* – the cylinders operate in parallel based on humidifier demand. This results in a lower turn-down ratio, but even wear on both steam cylinders.
- Series* – the cylinders are modulated in sequence to meet humidifier demand. Cylinder A will operate from 0-50% demand, and Cylinder B will operate from 51-100% demand.
- Independent* – the steam cylinders work independently based on control signals from two separate zones.

Factory setting: *Series*

Basic Tab, continued...



- **Control Mode CH 1/3:** allows you to select the general control mode for the incoming control signal.

Options:

*Demand* – control signal is from an external controller.

---

**IMPORTANT!** When the control is by others, ensure that BMS/Demand Signal is set with a P-band of 15% and I-time at 5 minutes.

P-band of less than 15% can result in operational issue.

---

*RH P* – control signal uses the internal P (proportional) controller to interpret sensed humidity into demand.

*RH PI* – control signal uses the internal PI (proportional-integral) controller to interpret sensed humidity into demand.

*On/Off* – control signal is from an external On/Off humidistat.



- **Control Mode CH 2/4:** allows you to select the general control mode for the incoming high limit signal. **Note:** This setting appears only if [Control Channels](#) is set to "Dual".

Options:

*Demand* – control signal is from an external controller.

---

**IMPORTANT!** When the control is by others, ensure that BMS/Demand Signal is set with a P-band of 15% and I-time at 5 minutes.

P-band of less than 15% can result in operational issue.

---

*RH P* – control signal uses the internal P (proportional) controller to interpret sensed humidity into demand.

*RH PI* – control signal uses the internal PI (proportional-integral) controller to interpret sensed humidity into demand.

*On/Off* – control signal is from an external On/Off humidistat.

Factory setting:

*Demand*

**Note:** Channel 3 and 4 are used to control cylinder B when [Dual Cylinder Mode](#) is set to "Independent"; otherwise they are ignored.

Basic Tab, continued...



- **Control Channels:** allows you set whether the humidifier is controlled by one or two signals.  
Options: *Single* – single control.  
*Dual* – Two control signals (typically a control, plus a high limit signal).  
Factory setting: *Dual*
- **Signal Type Channel 1/3:** allows you to select the signal type of the incoming control signal. **Note:** This setting is ignored if signal *Source* is not set to "Analog". Channel 3 applies only to units with dual steam cylinders set to operate in independent mode.  
Options: *0-5V, 1-5V, 0-10V, 2-10V, 0-20V, 0-16V, 3.2-16V, 0-20mA, 4-20mA*  
Factory setting: *0-20V*
- **Signal Type Channel 2/4:** allows you to select the signal type of the incoming high limit signal. **Note:** This setting is ignored if signal *Source* is not set to "Analog". Channel 4 applies only to units with dual steam cylinders set to operate in independent mode.  
Options: *0-5V, 1-5V, 0-10V, 2-10V, 0-20V, 0-16V, 3.2-16V, 0-20mA, 4-20mA*  
Factory setting: *0-20V*

## PI Control Parameters (A and B) Tab

**Note:** The PI Control Parameters tab appears as tab A and tab B on units with dual steam cylinders set to operate in independent mode. This menu appears only if *Control Mode* is set to "RH P" or "RH PI".



- **Setpoint Channel 1:** allows you to select the Setpoint menu, shown below. This menu allows you to set the humidifier to operate at different humidity setpoint values (% RH) using a timer function, or at a fixed humidity setpoint value.

### Setpoint Tab



Allows you to set a fixed humidity setpoint without the use of timers.

- **Setpoint Timers:** allow you to enable or disable the timer function, or configure up to eight different events with different humidity setpoint values.



**Timer:** allows you to enable or disable the Setpoint timer function.

Options: *On or Off*

Factory setting: *Off*

**Event "n":** allows you to define a setpoint that will be in effect by: day of the week or over a range of days, the start time and capacity. "n" represents events 1-8. Each event can also be turned off individually.

**Note:** The settings for an event are active up to the next event. Check the timer settings make sense, as the software does not check the plausibility of the settings. At least two events must be set. The *On/Off timer* overrides the Setpoint timer.

Setpoint Tab, continued...

- **Setpoint Channel 1:** allows you to set the humidifier to operate at a fixed humidity setpoint value at the specified time and date.  
 Setting range: 0-95% RH  
 Factory setting: 40% RH

PI Control Parameters Tab, continued from previous page...



- **Band Channel 1:** allows you to set the proportional range for the internal P/PI controller as a percentage of relative humidity (% RH) within which the humidifier will modulate between 0 and 100% output.  
 Setting range: 6-65%  
 Factory setting: 15%
- **ITime Channel 1:** allows you to set the integral time for error corrections by the internal P/PI controller.  
 Setting range: 1-60 minutes  
 Factory setting: 5 minutes
- **Setpoint Channel 2:** allows you to set the high limit setpoint value. **Note:** This setting appears only if *Control Channels* is set to "Dual".  
 Setting range: 0-95% RH  
 Factory setting: 80% RH



- **Band Channel 2:** allows you to set the proportional range for the internal P/PI controller as a percentage of relative humidity (% RH) within which the humidifier will modulate between 0 and 100% output. **Note:** This setting appears only if *Control Channels* is set to "Dual".  
 Setting range: 6-65%  
 Factory setting: 15%
- **Damp Channel 2:** allows you to set the time duration after which the high limit setpoint value takes control of the demand signal. **Note:** This setting appears only if *Control Channels* is set to "Dual".  
 Setting range: 1-60 seconds  
 Factory setting: 5 seconds

## RH Alerts Tab

**Note:** This tab appears only if *Control Mode* is set to "RH P" or "RH PI".

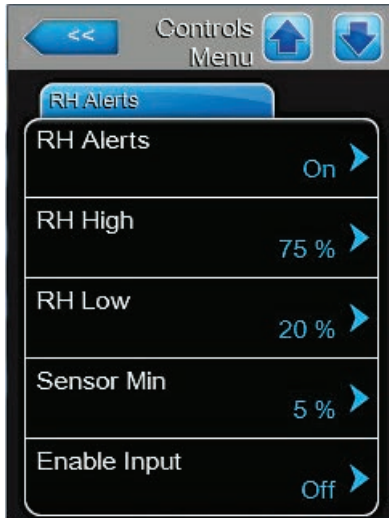

- **RH Alerts:** allows you to enable or disable the alert function that warns if sensed humidity is too high or too low.  
Options:                    *On* – enables the function.  
                                  *Off* – disables the function.  
Factory setting:        *Off*

**Note:** The following four settings are only available if the RH Alerts function is enabled.

- **RH High:** allows you to set the upper limit value of the humidity sensor signal. The RH High warning message is triggered when the signal value exceeds this limit.  
Setting range:        *20-95%*  
Factory setting:        *75%*
- **RH Low:** allows you to set the lower limit value of the humidity sensor signal. The RH Low warning message is triggered when the signal value drops below this limit.  
Setting range:        *20-95%*  
Factory setting:        *20%*
- **Sensor Min:** allows you to set the minimum signal value of the humidity sensor. If the signal value drops below this setting, the sensor is assumed to be damaged or disconnected. The RH Signal warning message is triggered when the signal value drops below this limit, and humidification stops.  
Setting range:        *1-10%*  
Factory setting:        *5%*
- **Enable Input:** allows you to enable or disable steam production using an external contact. When set to On, steam production will not be allowed unless the points of terminal X11 on the driver board are closed.  
Options:                    *On* – enables the function.  
                                  *Off* – disables the function.  
Factory setting:        *On*

## Multi-Unit Operation Tab

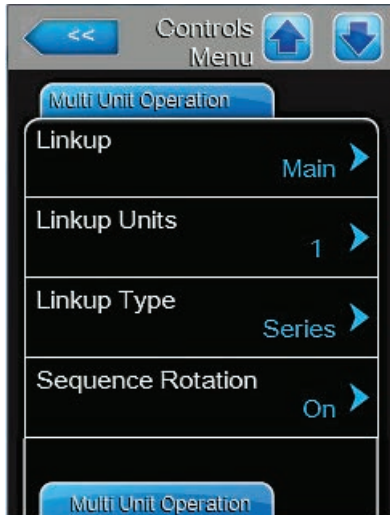

- **Linkup:** allows you to enable or disable the Linkup function, which allows up to six humidifier to connect and operate together from a single control signal. It also allows you to designate the humidifiers to operate as the main or extension unit(s).

Options:

- Main* – designated as the main (master) unit.
- Ext 1* – designated as the first extension unit.
- Ext 2* – designated as the second extension unit.
- Ext 3* – designated as the third extension unit.
- Ext 4* – designated as the fourth extension unit.
- Ext 5* – designated as the fifth extension unit.
- Off* – disables Linkup. The humidifier performs as a single unit.

Factory setting: *Off*

**Note:** The remaining settings in this tab are only available on the main unit when Linkup function is enabled.

- **Linkup Units:** allows you to set the number of humidifiers in the Linkup chain.

Setting range: 1-6

Factory setting: 1

- **Linkup Type:** allows you to select the mode of operation of the humidifier in the Linkup chain.

Options:

- Parallel* – the humidity demand (from a single zone) is distributed evenly on all humidifiers in the Linkup chain.
- Series* – the main unit operates to its maximum capacity, and as demand increases the extension units generate steam in sequential order. Each unit scales steam production in small increments. Series setting maximizes turndown.

*Independent* – should not be used for Linkup.

Factory setting: *Series*

- **Sequence Rotation:** allows you to enable or disable the function that manages the starting order to balance operating hours of all linked humidifiers. **Note:** This setting is available only if *Linkup Type* is set to "Series".

Options: *On* or *Off*.

Factory setting: *On*

Refer to "[Configuring for Multi-Unit Operation](#)" on page 55 for setup procedure.

Multi-Unit Operation Tab, continued...

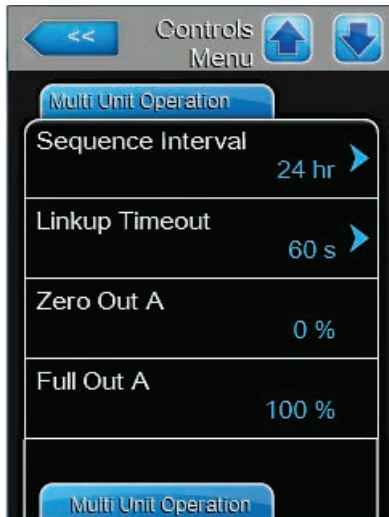

- **Sequence Interval:** allows you to set the time interval used by the control software to establish a new operating sequence to balance operating hours of linked humidifiers. **Note:** This setting is available only if [Sequence Rotation](#) is enabled.

Setting range: 24-1000 hours

Factory setting: 24 hours

- **Linkup Timeout:** allows you to set the maximum time limit that the units in the Linkup chain can operate without communication to each other before they generate a timeout warning message.

Setting range: 60-120 seconds

Factory setting: 60 seconds

- **Zero Out A:** shows the percentage value of the system demand signal at which cylinder A of the unit being examined is switched on.

- **Full Out A:** shows the percentage value of the system demand signal at which cylinder A of the unit being examined achieves 100% demand.

- **Zero Out B:** shows the percentage value of the system demand signal at which cylinder B of the unit being examined is switched on.

- **Full Out B:** shows the percentage value of the system demand signal at which cylinder B of the unit being examined achieves 100% demand.

**Note:** Zero Out B and Full Out B are only displayed if the unit being examined has dual cylinders.

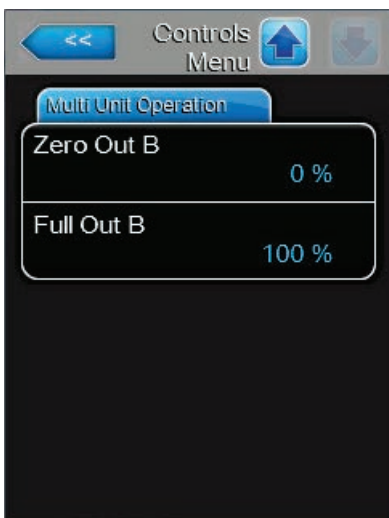



## General Menu

Each tab under the General menu is discussed below. Refer to [Table 5 on page 26](#) for the menu structure.

### Basic Tab

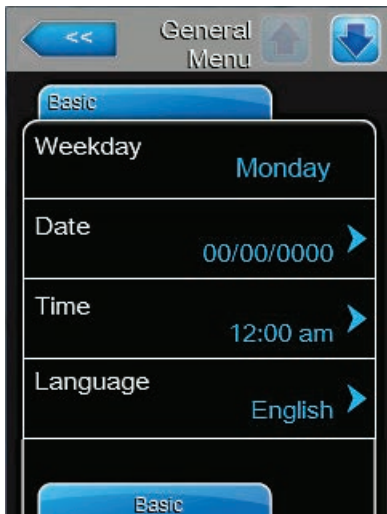

- **Date:** allows you to set the current date in MM/DD/YYYY or DD/MM/YYYY format depending on the [Date Format](#) setting.
- **Time:** allows you to set the current time in 12 hour or 24 hour format depending on the [Clock Format](#) setting.
- **Language:** allows you to select the language displayed on the touchscreen display.  
Options: *English, German, French, Italian, Spanish, Dutch, Danish, Finnish, Swedish, Polish, Czeck, Hungarian, Russian, Japanese or Chinese*

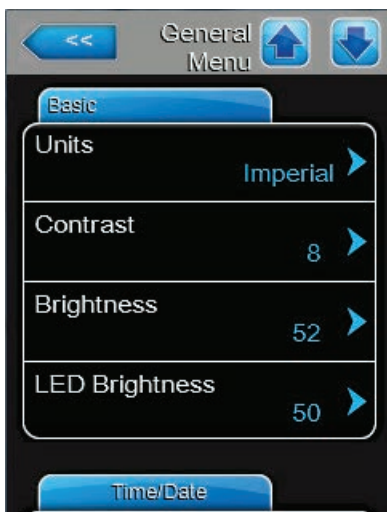

- **Units:** allows you to select the units of measurement.  
Options: *Imperial or Metric*
- **Contrast:** allows you to set the contrast level of the touchscreen display.  
Setting range: 1 (low) - 31 (high)  
Factory setting: 8
- **Brightness:** allows you to set the brightness level of the touchscreen display.  
Setting range: 1 (black) - 100 (white)  
Factory setting: 52
- **LED Brightness:** allows you to set the brightness level of the LED status indicator (refer to [Figure 4 on page 13](#)).  
Setting range: 1-100  
Factory setting: 50

## Time/Date Tab



- **Date Format:** allows you to select the date format.  
Options: MM/DD/YY or DD/MM/YY  
Factory setting: *MM/DD/YY*
- **Clock Format:** allows you to select the time format.  
Options: 12 hour or 24 hour  
Factory setting: *12 hour*

## Communication Menu

Each tab under the Communication menu is discussed below. Refer to [Table 5 on page 26](#) for the menu structure.

### Remote Enable Tab

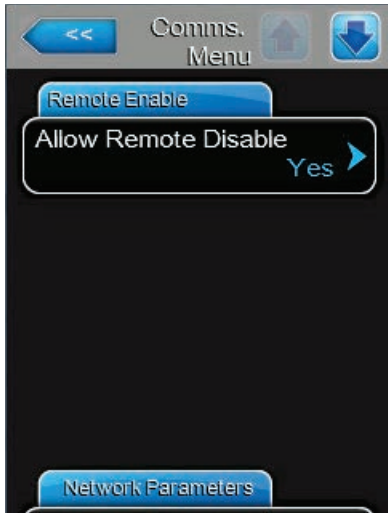

- **Allow Remote Disable:** allows you set whether steam production of the humidifier can be remotely disabled via the BMS.  
Options: Yes – remote disable permitted.  
No – remote disable not permitted.  
Factory setting: Yes

### Network Parameters Tab



The following settings are used only for communications via the integrated BACnet IP protocol, Condair Online and web pages.

- **IP Type:** allows you to select how the IP address settings are assigned.  
Options: *DHCP* – automatically acquire network address settings. **Note:** After five unsuccessful attempts to acquire the address, the system will revert to Fixed assignment.  
*Fixed* – manually configure the network address and settings.  
Factory setting: *DHCP*
- **IP Address:** allows you to manually set the IP address. Set the IP address only if *IP Type* is set to "Fixed".
- **Subnet Mask:** allows you to manually set the IP subnet mask for the IP network. **Note:** Set the subnet mask only if *IP Type* is set to "Fixed".
- **Default Gateway:** allows you to manually set the default gateway for the IP network. **Note:** Set the default gateway only if *IP Type* is set to "Fixed".

### Network Parameters Tab, continued...

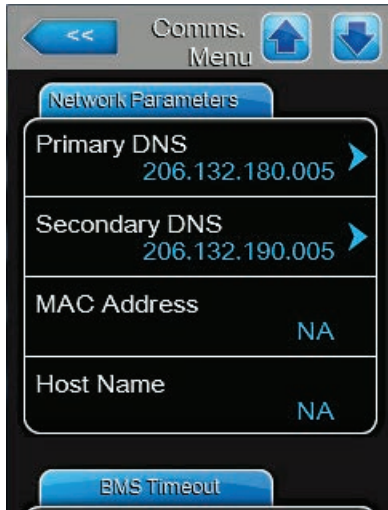

- **Primary DNS:** allows you to manually set the primary DNS (domain name server) for the IP address. **Note:** Set the primary DNS only if *IP Type* is set to "Fixed".
- **Secondary DNS:** allows you to manually set the secondary DNS (domain name server) for the IP address. **Note:** Set the secondary DNS only if *IP Type* is set to "Fixed"
- **MAC Address:** displays the MAC (media access control) address for the Nortec EL steam humidifier.
- **Host Name:** displays the host name for the Nortec EL steam humidifier.

### BMS Timeout Tab

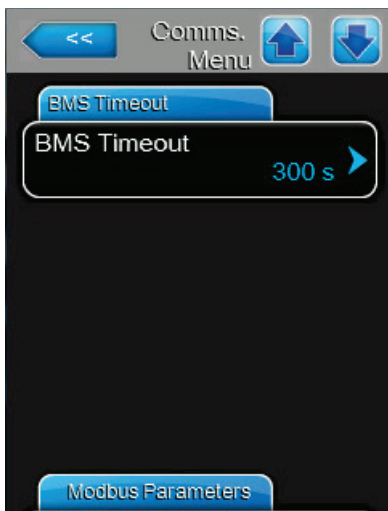

- **BMS Timeout:** allows you to set the maximum time the humidifier will wait without any communications from the BMS network before a timeout warning is generated.  
Setting range:            1-300 seconds  
Factory setting:         300 seconds

## Modbus Parameters Tab

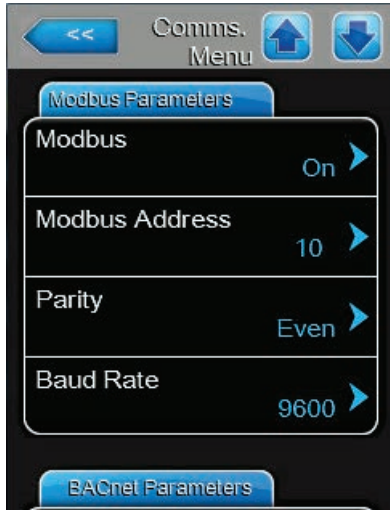

- **Modbus:** allows you to enable or disable the Modbus communications protocol. Enabling or disabling Modbus always requires a power cycle of the unit.

Options: *On or Off*

Factory setting: *Off*

The following settings appear only if *Modbus* is enabled.

- **Modbus Address:** allows you to set the Modbus address of the humidifier on the network.

Setting range: *1-247*

Factory setting: *10*

- **Parity:** allows you to set the parity bit for the data transfer.

Options: *None, Even or Odd*

Factory setting: *Even*

- **Baudrate:** allows you to set the baudrate for the data transfer.

Options: *110, 300, 600, 1200, 2400, 4800, 9600, 19200, 38400, 57600, 76800 or 115200*

Factory setting: *9600*

## BACnet Parameters Tab

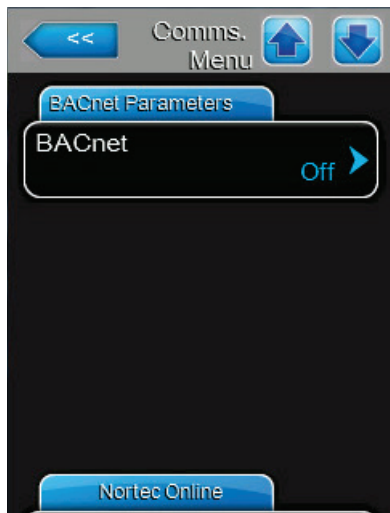

- **BACnet:** allows you to enable or disable the BACnet communications protocol. Enabling or disabling BACnet always requires a power cycle of the unit.

Options: *BACnet/IP* – enables BACnet/IP over the RJ45 (Ethernet) interface.

*MSTP* – enables BACnet MSTP over the RS485 interface. **Note:** The Nortec EL humidifier is both a master & slave BACnet MSTP device.

*Off* – disables BACnet communications protocol.

Factory setting: *Off*

BACnet Parameters Tab, continued...



The following settings appear only if *BACnet* is set to "BACnet/IP".

- **Device Name:** allows you to assign a name to the humidifier for communications over the BACnet/IP protocol.
- **Device Description:** allows you to enter a description for the humidifier.
- **Device Location:** allows you to enter the location of the humidifier.

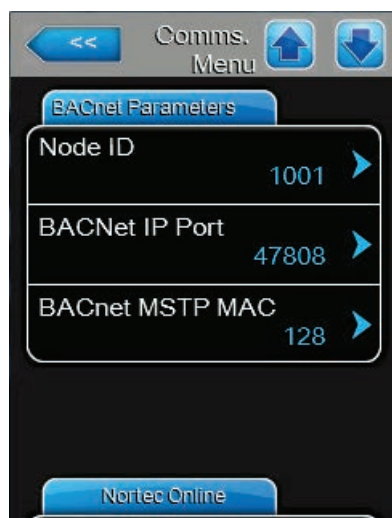

- **Node ID:** allows you to assign a node ID to the humidifier for communications over the BACnet/IP protocol.  
Setting range: 1-9999999  
Factory setting: 1001
- **BACnet IP Port:** allows you to assign a IP port number for the humidifier.  
Setting range: 1-65535  
Factory setting: 47808
- **BACnet MSTP MAC:** allows you to assign a MSTP MAC address for the humidifier.  
Setting range: 128-254  
Factory setting: 128



The following settings appear only if *BACnet* is set to "MSTP". **Note:** When set to BACnet MSTP the Nortec EL communicates as a BACnet slave and BACnet master.

- **Parity:** allows you to set the parity bit for the data transfer.  
Options: *None, Even or Odd*  
Factory setting: *Even*
- **Baud Rate:** allows you to set the baudrate for the data transfer.  
Options: *110, 300, 600, 1200, 2400, 4800, 9600, 19200, 38400, 57600, 76800 or 115200*  
Factory setting: *9600*
- **Device name:** allows you to assign a device name to the humidifier for communications over the BACnet/MSTP protocol.

BACnet Parameters Tab, continued...



- **Device Description:** allows you to enter a description for the humidifier.
- **Device Location:** allows you to enter the location of the humidifier.
- **Node ID:** allows you to assign a node ID to the humidifier for communications over the BACnet/MSTP protocol.  
Setting range: 1-9999999  
Factory setting: 1001
- **BACnet IP Port:** allows you to assign a IP port number for the humidifier.  
Setting range: 1-65535  
Factory setting: 47808
- **BACnet MSTP MAC:** allows you to assign a MSTP MAC address for the humidifier.  
Setting range: 128-254  
Factory setting: 128

Remote Fault Board Tab

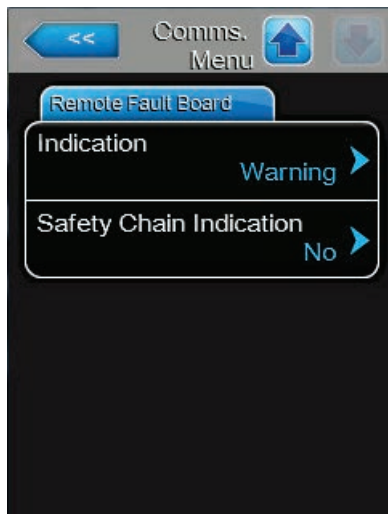

- **Indication:** allows you to select how system warnings are handled by the optional remote fault indication PCB.  
Options: *Warning* – activates the Service relay in the remote fault indication PCB when any system warnings or notifications are triggered.  
*Service* – activates the Service relay in the remote fault indication PCB only when service-related warnings are triggered.  
Factory setting: *Warning*
- **Safety Chain Indication:** allows you to enable or disable the function that activates the Service relay in the optional remote fault indication PCB when the safety chain is open.  
Options: *Yes* – activates the Service relay in the remote fault indication PCB if the safety chain is open.  
*No* – safety chain warning does not activate the service relay.  
Factory setting: *No*

### 4.2.7.2 Service Menu

The Service menu lets you reset the cylinder when it is replaced, access the fault and maintenance history lists and perform diagnostics. Refer to [Figure 7 on page 25](#). Refer to [Table 5 on page 26](#) for the menu structure.

Each tab under the Service menu is discussed below. The Service menu can also be accessed from the maintenance and fault status area on the Home screen – refer to [Figure 5 on page 15](#).

#### Startup Code Tab

**Note:** This tab only appears if the humidifier is being operated for the very first time, or the startup code has been enabled. Contact Condaire to request a startup code, then enter it in the field described below.

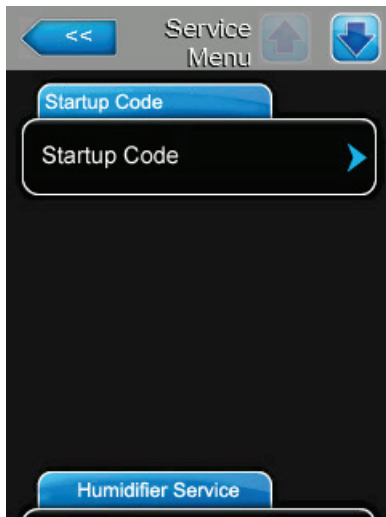

- **Startup Code:** allows you to enter the startup code required to operate the humidifier.

#### General Service Tab



- **Cylinder A Reset:** allows you to reset the Cylinder Spent service message after replacing cylinder A. A warning message is displayed asking you to confirm the reset.  
Options: Yes or No  
Factory setting: No
- **Cylinder B Reset:** allows you to reset the Cylinder Spent service message after replacing cylinder B. A warning message is displayed asking you to confirm the reset.  
**Note:** This setting appears only on units with dual steam cylinders.  
Options: Yes or No  
Factory setting: No



## Fault/Service History Tab

**Note:** Fault and maintenance history events can only be correctly analysed if the *date* and *time* are set correctly.



- **Fault History:** allows you to view the fault history list.
- **Service History:** allows you to view the service history list.
- **Export History:** allows you export the fault and service history list to a USB memory stick. Refer to ["Exporting Fault and Service History" on page 83](#).

**Note:** Insert a USB memory stick (formatted to 32-bit FAT system) into the USB port on the control board before selecting this function.

## Diagnostics Tab



- **Input Diagnostics:** allows you to access the Input Diagnostics menu which shows the current status of all inputs to the integrated control board, as well as calculated drain parameters.

### Cylinder (A and B) Tab

**Note:** The Cylinder B tab appears only on units with dual steam cylinders.



Diagnostics Tab, continued...



- **Relay Diagnostics:** allows you to access the Relay Diagnostics menu to enable or disable the relays on the optional remote fault board or the optional accessory relay board. **Note:** The diagnostic menu is only displayed after a warning message indicating that the humidifier will be placed in standby mode is acknowledged.

#### Remote Fault Board Tab



#### Accessory Board Tab

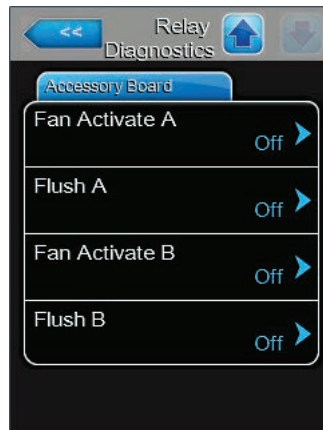

### 4.2.7.3 Administrator Menu

The Administrator menu lets you enable and disable password control, or install updates for the control software or the firmware for the driver board(s). Refer to [Figure 7 on page 25](#). Refer to [Table 5 on page 26](#) for the menu structure.

Each tab under the Administrator menu is discussed below.

#### Password Setting Tab

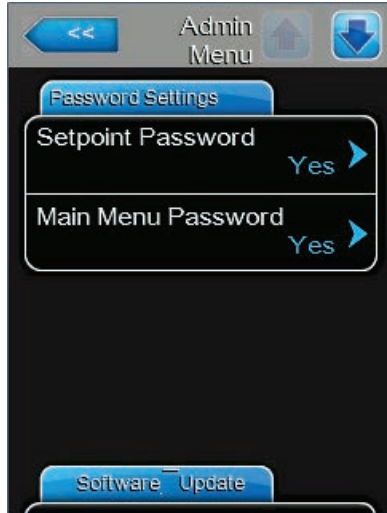

- **Setpoint Password:** allows you to enable or disable password control to modify setpoint values when the humidifier is configured to operate on internal RH(P) or RH(PI) control.  
Options: Yes – requires password to modify setpoint values.  
No – requires no password to modify setpoint values.
- **Main Menu Password:** allows you to enable or disable password control to access the Main menu.  
Options: Yes – requires password to access the Main menu.  
No – requires no password to access the Main menu.

## Software Update Tab



- **Software Update:** allows you to update the control software. Refer to *"Installing Software and Firmware Updates" on page 73.*
- **Driver Board A.DB.A:** allows you to update the driver board firmware for steam cylinder A. Refer to *"Installing Software and Firmware Updates" on page 73.*
- **Driver Board A.DB.B:** allows you to update the driver board firmware for steam cylinder B. **Note:** This setting appears only on units with dual steam cylinders. Refer to *"Installing Software and Firmware Updates" on page 73.*

## Software Settings Tab

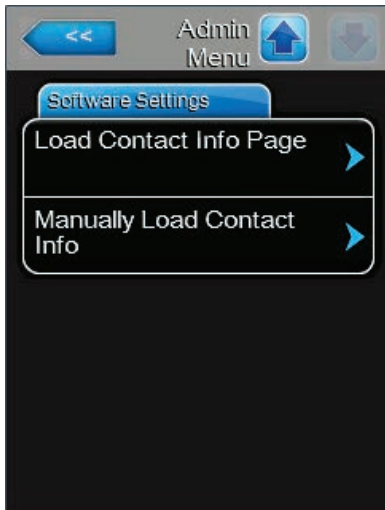

- **Load Contact Info Page:** allows you to update the contract/technical support information from a file on a USB memory stick. Please contact your Condair representative for assistance with this.
- **Manually Load Contact Info:** allows you manually enter the contract/technical support information. Please contact your Condair representative for assistance with this.

## 4.3 Software Configuration

The Nortec EL steam humidifier is shipped fully configured from the factory to suit your site-specific requirements, but this can be modified as needed. This section provides the necessary instructions to reconfigure the control software, or configure the humidifier to operate as part of a multi-unit system.

### 4.3.1 Configuring the Control Software

Perform the basic setup of the control software as follows, if necessary:

1. Make sure that all control wiring and jumpers are installed as described in "External Connections" in the Installation Manual.
2. Set up the following parameters:
  - **Source** – select the type of control signals to the humidifier ("Analog", "Modbus", "BACnet/IP", etc.). Select "Analog" if a sensor/transducer signal, or a demand signal from an external P/PI (proportional)/(proportional-integral) controller is wired directly to the humidifier. Otherwise, select an applicable digital communication protocol from the list. If your humidifier has the optional Lonworks or BACnet (BTL) module installed, select "Modbus".
  - **Dual Cylinder Mode** (on large units with dual steam cylinders only) – select the mode of operation ("Parallel", "Series" or "Independent") of the two steam cylinders.  
If two separate sets of control signals are available to the humidifier from two separate zones that require humidification, select "Independent" to operate the two steam cylinders independent of each other. Otherwise, select "Parallel" or "Series", as appropriate.
  - **Control Channels** – select the number of control channels.  
Select "Dual" if controlling the humidifier with a high limit and a control signal; otherwise set to "Single".
  - **Control Mode CH1/3** and **Control Mode CH2/4** – select the general control mode for the incoming control and limit signal ("Demand", "RH P", "RH PI", or "On/Off").  
Select "Demand" if the control signal is a demand signal from an external controller. Select "RH P" or "RH PI", as appropriate, if the control signal is from a sensor/transducer. Or select "On/Off" if the control signal is from an external On/Off humidistat. **Note:** **Control Mode CH2/4** must only be set if **Control Channels** is set to "Dual".  
**Note:** On Nortec EL humidifiers with dual steam cylinders, if the **Dual Cylinder Mode** selection is set to "Independent" and the **Control Channels** selection is set to "Dual", the Control Mode setting and the Signal Type setting (described below) also extends to the control signals on Channel 3 and Channel 4.
  - **Signal Type Channel 1/3** and **Signal Type Channel 2/4** – select the signal type of the incoming control signal if **Control Mode** is set to "Demand", "RH P" or "RH PI", and signal **Source** is set to "Analog".  
Select from "0-5V", "1-5V", "0-10V", "2-10V", "0-20V", "0-16V", "3.2-16V", "0-20mA", or "4-20mA", as appropriate for the external control device connected to Channel 1. **Note:** **Signal Type Channel 2/4** must only be set if **Control Channels** is set to "Dual".
  - **Enable Input** – if an external control has been connected to terminal X11 on the Nortec EL's driver board to remotely disable the humidifier, then set the Enable Input function to "On", if required.  
**Note:** The external contact connected to "X11" on the driver board can be used to enable or disable the humidifier. This is in addition to any On/Off devices in the safety loop or the On/Off input connected to Channel 1 that are used to enable or disable the humidifier.

This concludes the basic setup of the control software.

**Note:** The humidifier can also be controlled using [Capacity Timers](#), or [Setpoint Timers](#), or [On/Off Timers](#). If assistance is required to set it up, please contact your Condaire representative.

### 4.3.2 Configuring for Multi-Unit Operation

Set up the control software for multi-unit operation as described below. A maximum of six humidifiers can be set up in a "main-extension" configuration the Linkup system to satisfy large humidification needs.

---

**IMPORTANT!** This procedure should only be used to control multiple humidifiers that are using the same control signal inputs from the same conditioned environment.

---

1. Make sure that all wiring and jumpers are installed, as described in "Connecting Multiple Units Using Linkup" in the Installation Manual.
  2. Configure the main humidifier as described in "[Configuring the Control Software](#)" on page 54.
  3. Set *Linkup* to "Main" on the humidifier that will be designated "Main" in the Linkup chain, and set up the following parameters on it:
    - *Linkup Units* – select the total number of humidifiers in the Linkup chain. For example, if there is one main unit and two extension units, then the total number of humidifier in the chain is 3.
    - *Linkup Type* – select the mode of operation of the humidifiers in the Linkup chain ("Series" or "Parallel").
    - *Sequence Rotation* – enable or disable the function that manages the starting order to balance the operating hours on each steam cylinder. **Note:** This setting is available only if *Linkup Type* is set to "Series".
    - *Sequence Interval* – set the time interval used by the control software to establish a new operating sequence to balance the operating hours on the steam cylinders in the Linkup chain.
    - *Linkup Timeout* – if required, change the maximum time limit that the units in the Linkup chain can operate without a connection to each other before they generate a Linkup Timeout warning message.
  4. Set *Linkup* in each extension humidifier as Ext1, Ext2,...
- Note:** Each extension unit must be a unique extension number.

The humidifiers in the Linkup chain are now set up to generate steam upon humidity demand.

This page intentionally left blank



# 5 Operation

## 5.1 General

### Personnel Qualifications

The Nortec EL steam humidifier must only be operated by personnel who are adequately qualified, well trained and are authorized by the customer.

### Safety

Certain operations of the Nortec EL steam humidifier may require the user to access the control cabinet or plumbing cabinet, which may expose the user and equipment to the hazards described below.



**DANGER!**  
Risk of electric shock!

**The Nortec EL steam humidifier is mains powered. Live parts may be exposed when the door panels are removed. Touching live parts may cause severe injury or even death.**

**Prevention:** Shut down the unit as described in ["Shutting Down" on page 62](#) before opening the door panels.



**WARNING!**  
Risk of severe burns from exposure to hot steam vapours!

**The Nortec EL steam humidifier produces hot steam vapours. Contact with the hot steam vapours can result in severe burns.**

**Prevention:** Never open the plumbing cabinet in the humidifier while it is operating, or expose skin to escaping steam vapours.



**WARNING!**  
Risk of severe burns from contact with hot surfaces!

**Components of the steam system may reach 212°F (100°C) during operation. Contact with the hot surfaces can result in severe burns.**

**Prevention:** Avoid touching any components in the plumbing cabinet until the unit has cooled down.



**CAUTION!**  
Electrostatic discharge (ESD)!

**The electronic components inside the control cabinet in the humidifier are sensitive to electrostatic discharge (ESD).**

**Prevention:** Take appropriate measures to protect the electronic components inside the unit against damage caused by electrostatic discharge (ESD). Refer to ANSI/ESD-S20.20.

## 5.1 Operating Procedures

### 5.1.1 Starting Up

Start up the Nortec EL steam humidifier as follows:

1. Set the On/Off button to the On position – refer to [Figure 4 on page 13](#).

The control software then starts initializing and performs system checks. When initialization and system checks are completed successfully, the Home screen is displayed on the touchscreen display – refer to [Figure 5 on page 15](#). The humidifier goes into the normal operating mode.

If a valid humidity demand signal is present the contactor closes, and after a 60 second delay the fill valve opens and begins to fill the steam cylinder(s) with water. When the water level rises and makes contact with the electrodes, the water starts to heat and the status LED turns green in color. Depending on the conductivity of the water, it may take approximately 30-60 minutes to generate steam on the first startup.

**Note:** If the water conductivity is low, it is possible that the humidifier does not output steam at full capacity during the first few hours (or even days) of operation. This is quite normal. As vaporization continues the mineral concentration increases and the conductivity of water reaches an optimum level, at which point the humidifier will start to output steam at full capacity.

If there is no humidity demand the status LED turns to a flashing green, and the humidifier goes into standby mode to await the next humidity demand signal.

### 5.1.2 Remote Monitoring

The Nortec EL steam humidifier can be monitored remotely if it is equipped with an optional remote fault indication board and wired to a remote monitoring system. [Table 6](#) describes the function of each relay on the board. Refer to [Indication](#) and [Safety Chain Indication](#) for additional details.

*Table 6: Remote Fault Indication Function*

Remote Relay	Description
Error	The humidifier is stopped due to a fault condition, or may be operable only for a limited period of time.
Service/Warning	Depending on the software configuration, indicates if the cylinder is spent, and/or if a warning condition is present.
Steam	A humidity demand is present, and the humidifier is producing steam.
Unit On	The humidifier has power, and the On/Off switch is in the On position.

The Nortec EL steam humidifier may also be monitored remotely from a laptop or desktop computer using the ethernet port on the control board. Please contact your local Condaire representative for assistance.

### 5.1.3 Inspections During Operation

Perform regular inspection of the Nortec EL steam humidifier and the humidification system when it is in operation. Inspect the following:

- Check the water and steam connections for any leakages.
- Check the humidifier and other system components have not shifted from their mountings, and are fastened securely.
- Visually check the electrical wiring for any damage.
- Check the Home screen on the humidifier for maintenance or alarm messages.

If any irregularities (leakages, fault messages or damaged components) are found, shut down the Nortec EL steam humidifier before performing service – refer to ["Shutting Down" on page 62](#). If you require assistance, contact your Condair representative for assistance.

### 5.1.4 Manually Initiate Steam Cylinder Draining

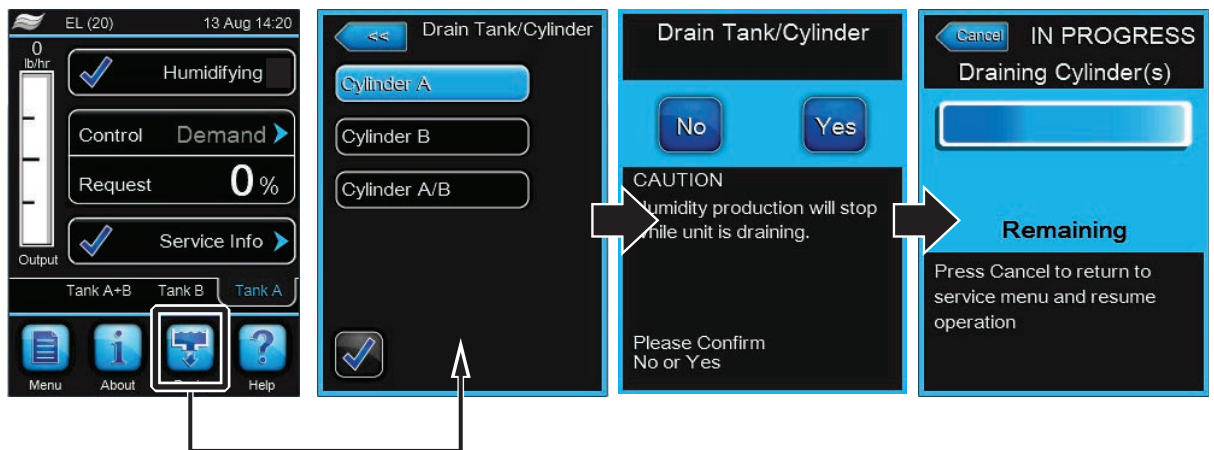

Figure 8: Drain Screens

Manually initiate draining of the steam cylinder(s) in the Nortec EL steam humidifier as follows. Refer to [Figure 8](#).

1. Select the **<Drain>** button on the Home screen.
2. If you have a dual cylinder humidifier select the cylinder(s) to drain, then press the check mark.
3. Select the **<Yes>** button on the confirmation screen. If humidification is in progress, it is interrupted and the drain valve empties the steam cylinder(s). A progress bar shows the status of the drain cycle. Select the **<Cancel>** button at any time to interrupt the drain cycle and return to the previous screen.

**Note:** If necessary, set the On/Off switch to the Off position at the end of the drain cycle to prevent the humidifier from filling the steam cylinder again.

**Note:** If the control software/drain valve does not function properly, shut down the humidifier – refer to ["Shutting Down" on page 62](#). Then disconnect the fill hose (fill cup to cylinder) at the fill cup, and drain the cylinder. Refer to [Figure 9 on page 60](#).



**WARNING!**

**Cylinder may contain hot water or steam. Risk of severe burn injury!**

**Prevention:** Always wait for the unit to cool down to a safe temperature before draining the cylinder manually using the fill hose.

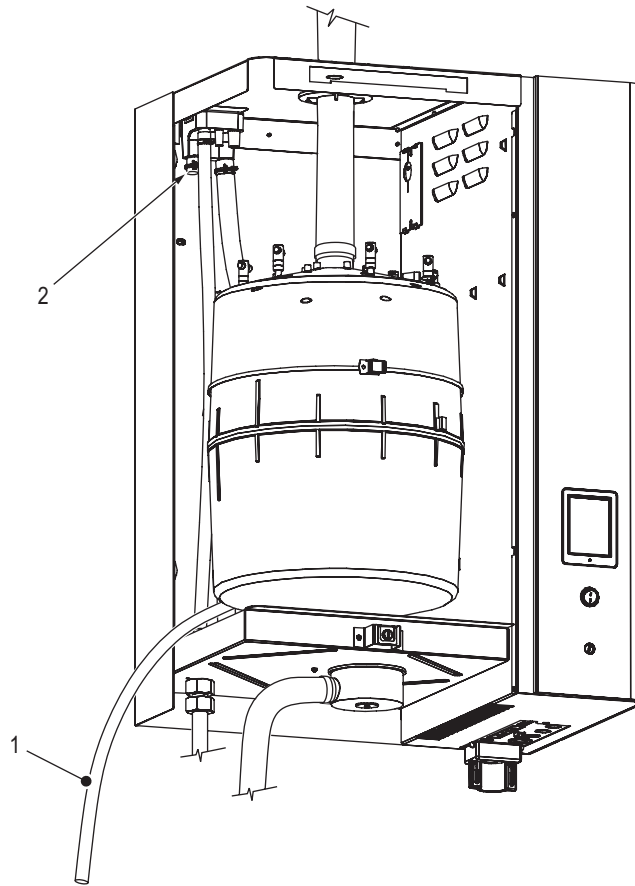



Figure 9: Disconnecting Fill Hose

- 1 Fill hose (fill cup to cylinder) – disconnected at the fill cup
- 2 Hose connection, fill cup

### 5.1.5 Exporting Trend Data

Export the humidifier performance data to a USB memory stick as follows. Refer to [Figure 10 on page 61](#).

 **DANGER!**  
Risk of electric shock!

**The Nortec EL steam humidifier is mains powered. Live parts may be exposed when the door panels are removed. Touching live parts may cause severe injury or even death.**

**Prevention:** Shut down the humidifier properly at the external disconnect switch before accessing the control board in the humidifier.

1. Set the On/Off button to the Off position.
2. Disconnect the power supply to the humidifier at the external disconnect switch. To prevent accidental power-up, lockout and tag out according to the established safety practices at your facility.
3. Remove the door panel on the control cabinet in the humidifier – refer to ["Removal and Installation of Door Panels" on page 65](#).

**CAUTION!** Any previous trend data on the memory stick will be over-written.

4. Carefully insert a USB memory stick (formatted to 32-bit FAT system) into the USB port. Make sure that the maximum length of the memory stick does not exceed 3 in (75 mm).

5. Close the front panel, and install the door panel.
6. Remove the lock and tag from the external disconnect switch, and restore power to the humidifier.
7. Set the On/Off button to the On position.
8. When the Home screen appears, select the **<About>** button, then **General tab > Export Trend Data**. The humidifier performance data for the previous 24 hours is then downloaded to the memory stick as a file labelled TREND.csv.  
Press the **<Cancel>** button at any time to abort the operation.
9. Repeat [Step 1](#) to [Step 3](#), and carefully remove the USB memory stick.
10. Close the front panel. Install the door panel making sure that it is fastened securely – refer to "[Removal and Installation of Door Panels](#)" on page 65.
11. Repeat [Step 6](#) and [Step 7](#) to power up the humidifier.

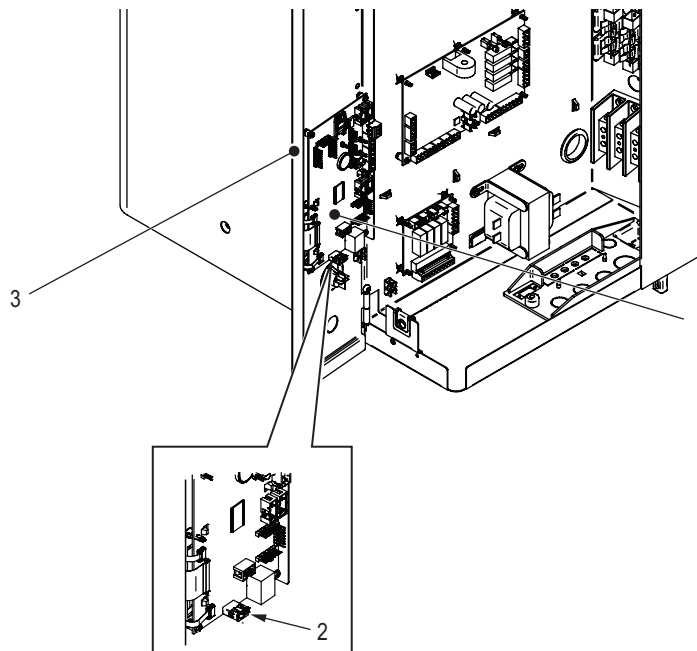

Figure 10: Accessing the Control Board

- 1 Control board
- 2 USB port
- 3 Front panel

## 5.1.6 Shutting Down



**DANGER!**  
Risk of electric shock!

**The control cabinet in the Nortec EL steam humidifier has live voltage. Turning off the unit at the On/Off switch does not shut off power to the control cabinet. Touching live parts may cause severe injury or even death.**

**Prevention:** Before performing any work inside the humidifier or with the humidification system, shut down the humidifier properly as described below.

Shut down the Nortec EL steam humidifier as follows:

1. If the humidifier needs maintenance, or it needs to be taken out of service for long-term storage, manually initiate drain of the steam cylinder(s). Refer to ["Manually Initiate Steam Cylinder Draining" on page 59](#).
2. Shut off the water supply to the humidifier.
3. Make a note of the fault code, if any, displayed on the Home screen.
4. Set the On/Off button to the Off position.
5. Disconnect the power supply to the humidifier at the external disconnect switch. To prevent accidental power-up, lockout and tag out according to the established safety practices at your facility.



**WARNING!**  
Risk of severe burns from contact with hot surfaces!

**Components of the steam system may reach 212°F (100°C) during operation. Contact with the hot surfaces can result in severe burns.**

**Prevention:** Avoid touching any components in the plumbing cabinet until the unit has cooled down to room temperature.

6. Wait for the unit to cool down to a safe temperature before performing any maintenance inside the plumbing cabinet.

## 5.1.7 Restarting After Shutdown

Restart the Nortec EL steam humidifier after a shutdown as follows:



**DANGER!**  
Risk of harm to personnel or damage to property.

**Operating a damaged or improperly secured humidifier presents a risk of danger to personnel or damage to property.**

**Prevention:** Do not restart a damaged or improperly secured humidifier.

1. Examine the humidifier and other system components for damage. Check for loose or damaged electrical connections, and make sure that the humidifier and its components have not shifted from their mountings, and are fastened securely.
2. Turn on the water supply to the humidifier, and check for any water leaks.
3. Install both door panels. Make sure that they are fastened securely. Refer to ["Removal and Installation of Door Panels" on page 65](#).
4. Remove the lock and tag from the external disconnect switch, and restore power to the humidifier.
5. Set the On/Off button to the On position.  
The humidifier then powers up and awaits a humidity demand signal to resume steam production.

# 6 Maintenance

## 6.1 General

Perform only those maintenance procedures described in this manual, and follow all instructions closely. Use only original Condair replacement parts.

### Personnel Qualifications

Maintenance work in the Nortec EL steam humidifier must only be performed by well qualified and properly trained personnel authorized by the customer. It is the customer's responsibility to verify qualifications of the personnel.

### Safety

Certain maintenance tasks in the Nortec EL steam humidifier may require the user to access the inside of the control and plumbing cabinets in the humidifier, which may expose the user and equipment to the hazards described below.



**DANGER!**  
Risk of electric shock!

**The Nortec EL steam humidifier is mains powered. Live parts may be exposed when the door panels are removed. Touching live parts may cause severe injury or even death.**

**Prevention:** Shut down the unit as described in *"Shutting Down" on page 62* before performing any maintenance work.



**WARNING!**  
Risk of severe burns from exposure of skin to hot water or hot steam vapours!

**The water in the steam cylinder(s) in the humidifier can be up to 203°F (95°C). Contact with the hot water or hot steam vapours can result in severe burns.**

**Prevention:** Shut down the unit as described in *"Shutting Down" on page 62* and wait for the unit to cool down before performing any maintenance work.



**WARNING!**  
Risk of severe burns from contact with hot surfaces!

**Components of the steam system may reach 212°F (100°C) during operation. Contact with the hot surfaces can result in severe burns.**

**Prevention:** Avoid touching any components in the plumbing cabinet until the unit has cooled down to room temperature.



**CAUTION!**  
Electrostatic discharge (ESD)!

**The electronic components inside the control cabinet in the humidifier are sensitive to electrostatic discharge (ESD).**

**Prevention:** Take appropriate measures to protect the electronic components inside the unit against damage caused by electrostatic discharge (ESD). Refer to ANSI/ESD-S20.20.

## 6.2 Maintenance List

Regular maintenance of the Nortec EL steam humidifier is a requirement for maintaining the safety and operational efficiency of the humidifier. Maintenance of the Nortec EL steam humidifier is broken down into two categories – regular replacement of the steam cylinder(s), and regular maintenance of the steam humidifier.

### 6.2.1 Regular Replacement of Steam Cylinder(s)

The Nortec EL steam humidifier control software monitors the performance of the cylinder and indicates when a cylinder is full of scale and no longer able to achieve full output.

When the control software detects the cylinder can no longer achieve full output, the "Cylinder Spent" warning message appears on the Home screen. Replace the steam cylinder(s) – refer to ["Removal and Installation of Steam Cylinder" on page 66](#).

**Note:** If the steam cylinder is not replaced, and the maintenance counter is not reset within 72 hours (run time), a corresponding fault message appears.

### 6.2.2 Regular Maintenance of Steam Humidifier

Regular maintenance should be performed on the Nortec EL steam humidifier at least once a year, and whenever the cylinder is replaced.

Table 7: Maintenance List

Component	Description	Frequency
Drain valve	Inspect and clean, if necessary – refer to <a href="#">"Removal and Installation of Drain Valve" on page 68</a> .	During cylinder change
Fill valve	Remove and clean the fill valve strainer.	Annually
Drain cup	Inspect and clean, if necessary.	Annually
Fill cup and hoses	Inspect and clean, if necessary.	Annually
Steam installation	Inspect the steam and condensate hoses in the humidifier for cracks, and check that they are fastened securely. Replace cracked hoses.	Annually
Water installation	Inspect the water hoses for cracks, and check that they are fastened securely. Replace cracked hoses. Clean the water filter in the supply line.	Annually
Electrical installation	Inspect all cables for damage and insulation breakdown. Replace damaged cables. Make sure that all cables are securely properly.	Annually
Main electrical contactor(s) (K1)	Replace the main electrical contactor(s) (K1). Refer to the instructions that come with the replacement contactors.	At least once every 5 years



## 6.3 Maintenance Procedures

Make sure that the humidifier is shut down properly as described in ["Shutting Down" on page 62](#), and observe all safety precautions before performing any maintenance work on the humidifier.

### 6.3.1 Removal and Installation of Door Panels

#### Removal

Remove the two door panels in the humidifier as follows. Refer to [Figure 11](#).

1. Turn the captive screw in each door panel counter-clockwise with a screwdriver.
2. Lift up the door panel slightly so that the tabs clear the notches in the cabinet, then carefully remove the panel.

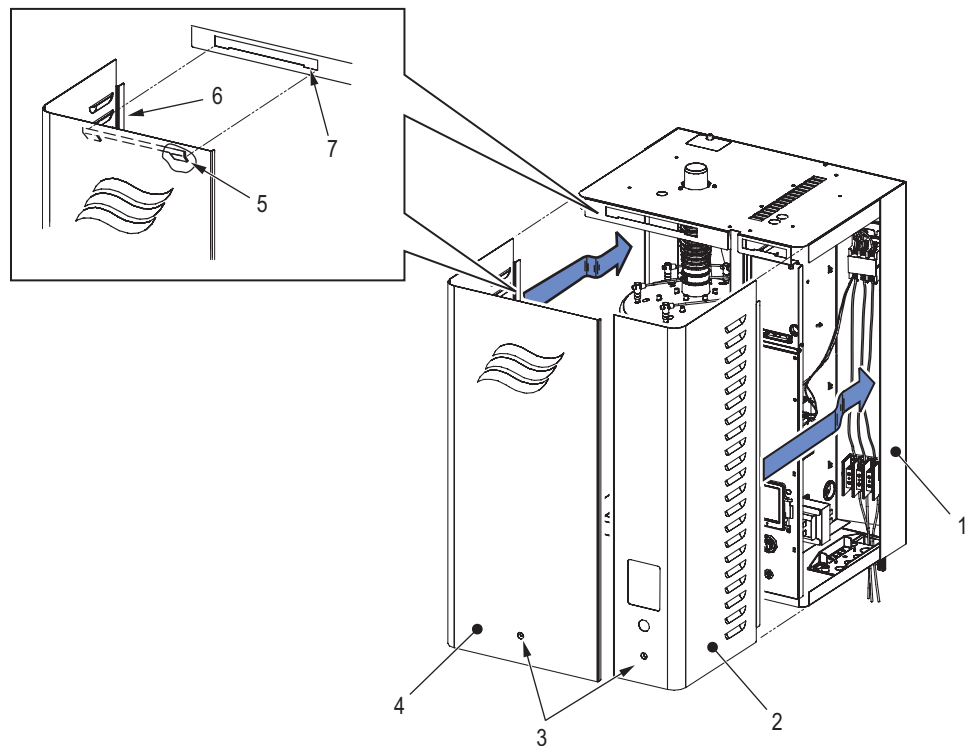

Figure 11: Door Panels Removal and Installation

- |   |                              |   |                      |
|---|------------------------------|---|----------------------|
| 1 | Stationary panel             | 5 | Top tab, door panel  |
| 2 | Door panel, control cabinet  | 6 | Long tab, door panel |
| 3 | Captive screw                | 7 | Notch, cabinet       |
| 4 | Door panel, plumbing cabinet |   |                      |

#### Installation

Install the two door panels in the humidifier as follows. Refer to [Figure 11](#).

1. Position each door panel so that the two tabs in the top rear of the panel align with the notches in the cabinet.
2. Lower the door panel to seat the tabs in the notches, while ensuring that the long tab on the side of the panel slides behind the stationary panel.
3. Make sure that the door panel fits flush on the front and the side. Turn the captive screw in the door panel clockwise with a screwdriver to secure the door panel. Check that it is fastened securely.

## 6.3.2 Removal and Installation of Steam Cylinder

### Removal

Remove the steam cylinder as follows. Refer to [Figure 12](#).



#### WARNING!

**Risk of severe burns from contact with hot surfaces, steam or hot water!**

The steam cylinder temperature may be up to 212°F (100°C), and may contain steam or hot water at up to 212°F (100°C). Contact with the hot surfaces, steam vapors or hot water can result in severe burns.

**Prevention:** Avoid touching any components in the plumbing cabinet until the unit has cooled down to room temperature.

1. Shut down the humidifier as described in ["Shutting Down" on page 62](#).
2. Remove the door panels – refer to ["Removal and Installation of Door Panels" on page 65](#).
3. Loosen the hose clamp that secures the steam hose to the steam outlet in the cylinder, and slide the clamp up on the hose.
4. Disconnect all the electrode plugs from the electrodes in the steam cylinder.
5. Disconnect the plug from the high water level sensor.
6. Release the tab in the strap that secures the steam cylinder, and pull the strap open.
7. Tilt the steam cylinder forward so the steam outlet disengages from the steam hose, then remove the cylinder from the drain valve.
8. Remove and discard the O-ring in the drain valve.

### Installation

Install the steam cylinder as follows. Refer to [Figure 12 on page 67](#).

1. For safety reasons, always install a new O-ring in the drain valve when installing a new steam cylinder. Lubricate the O-ring with water – do not use grease or oil, or any other lubricant.
2. Make sure that the new steam cylinder is of the same model as the one that was removed. The model number for the steam cylinder is located on the upper left corner of the cylinder label.
3. Holding the cylinder at a slight angle, carefully slide the bottom of the steam cylinder into the drain valve.
4. Pull the steam hose forward to engage the steam outlet in the cylinder. Tip the cylinder back while pulling the steam hose over the steam outlet until the cylinder is seated in the drain valve and the steam hose is engaged on the steam outlet.
5. Install the strap and secure the steam cylinder in place.



#### CAUTION!

**Risk of damage to the steam outlet on the cylinder!**

The steam outlet in the steam cylinder is made of plastic. **Do not** over-tighten the hose clamp.

A leaky steam hose can cause damage to the components inside the humidifier.

6. Pull the hose down and torque the hose clamp to a maximum of 12 in·lbs (135 N·cm) for a 7/8 in (22 mm) steam hose, or 16 in·lbs (180 N·cm) for a 1-3/4 in (45 mm) steam hose.
7. Connect the electrode plugs to the electrodes in the steam cylinder. The electrode pins and the electrode plugs are color-coded – make sure that they match, and are installed correctly.
8. Connect the plug to the high water level sensor.

9. Restart the humidifier as described in ["Restarting After Shutdown" on page 62.](#)
10. Reset the cylinder – refer to ["Resetting Cylinder" on page 72.](#)

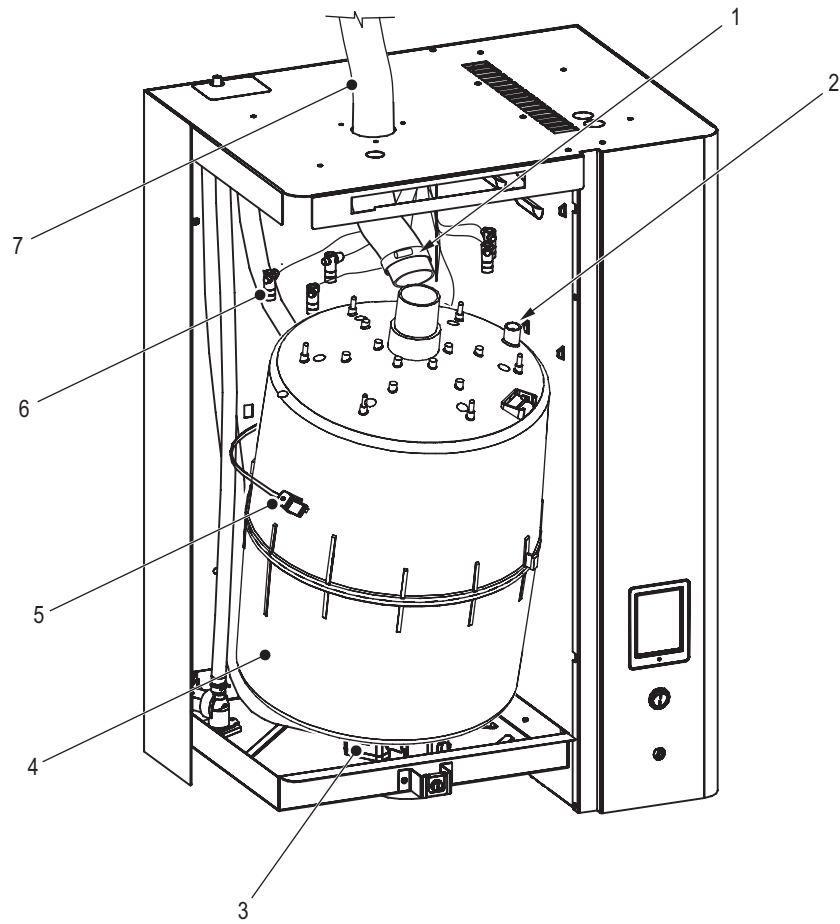

*Figure 12: Steam Cylinder Removal and Installation*

- 1 Hose clamp
- 2 Socket, high water level sensor
- 3 Drain valve
- 4 Steam cylinder
- 5 Strap
- 6 Electrode plug
- 7 Steam hose

### 6.3.3 Removal and Installation of Drain Valve

#### Removal

Remove the drain valve as follows. Refer to [Figure 13](#).

1. Remove the steam cylinder – refer to ["Removal and Installation of Steam Cylinder" on page 66](#).
2. Release the hose clamp, and disconnect the fill hose (fill cup to cylinder) from the drain valve.
3. Disconnect the electrical connectors and the ground wire from the drain valve.
4. Remove the two screws that secure the drain valve to the cabinet.
5. Remove and discard the O-ring in the drain valve.
6. To disassemble the valve, loosen the brass nut and remove the solenoid assembly from the valve body.
7. Disassemble the solenoid assembly, and clean all components.

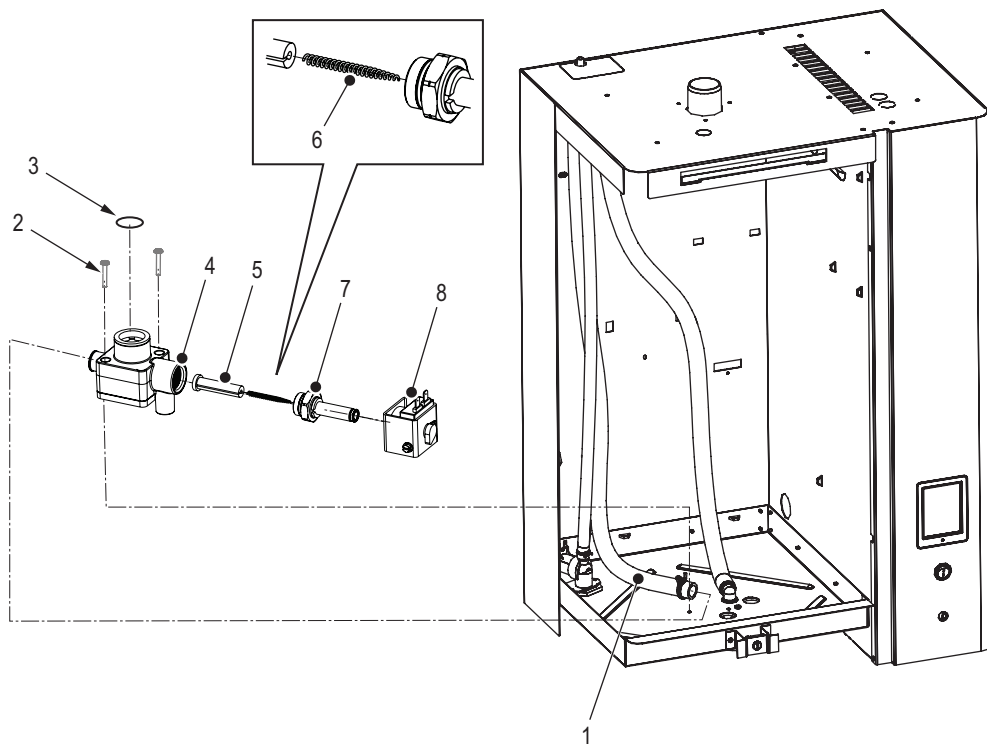

*Figure 13: Drain Valve Removal and Installation*

- 1 Fill hose (fill cup to cylinder)
- 2 Screw (×2)
- 3 O-ring
- 4 Valve body
- 5 Plunger
- 6 Spring (note its orientation)
- 7 Brass nut and solenoid
- 8 Solenoid

#### Installation

Install the drain valve as follows. Refer to [Figure 13](#).

1. For safety reasons, always install a new O-ring in the drain valve.
2. Assemble the solenoid assembly making sure that the tapered end of the spring is oriented as shown.
3. Assemble the solenoid assembly to the valve body, and hand-tighten. Then turn an additional quarter turn.
4. Install the drain valve and secure it to the cabinet with the two screws.

5. Connect the fill hose to the drain valve, and secure it with the hose clamp.
6. Connect the electrical connectors and the ground wire to the drain valve.
7. Install the steam cylinder – refer to ["Removal and Installation of Steam Cylinder" on page 66](#).

### 6.3.4 Replacement of Backup Battery and Fuses



**DANGER!**  
Risk of electric shock!

**The Nortec EL steam humidifier is mains powered. Live parts may be exposed when the door panels are removed. Touching live parts may cause severe injury or even death.**

**Prevention:** Shut down the unit as described in ["Shutting Down" on page 62](#) before replacing the backup battery or fuses.



**CAUTION!**  
Electrostatic discharge (ESD)!

**The electronic components inside the control cabinet in the humidifier are sensitive to electrostatic discharge (ESD).**

**Prevention:** Take appropriate measures to protect the electronic components inside the unit against damage caused by electrostatic discharge (ESD). Refer to ANSI/ESD-S20.20.

Only a qualified service technician authorized by the customer should replace the backup battery in the control board and the fuses in the driver board(s).

Always replace defective fuses with new fuses that match the specification given in the procedure below.

**Never** short-circuit and bypass the fuses.

Replace the backup battery in the control board, and the fuses in the driver board(s) as follows. Refer to [Figure 14 on page 70](#).

1. Remove the door panel on the control cabinet. Remove the locking screw and swing the front panel open.
2. Replace the backup battery in the control board with a new 3V battery (CR 2032).
3. Replace the fuse "F1" with a new slow-acting 1A fuse.

---

**IMPORTANT!** For safety reasons, always install the protective cover on the fuse "F3".

---

4. Remove the protective cover over the fuse "F3" in the driver board. Replace the fuse with a new slow-acting 4A fuse. Install the protective cover on the fuse.
5. Close the front panel and install the locking screw to secure it. Install the door panel, making sure that it is fastened securely.
6. Remove the lock and tag from the external disconnect switch, and restore power to the humidifier.

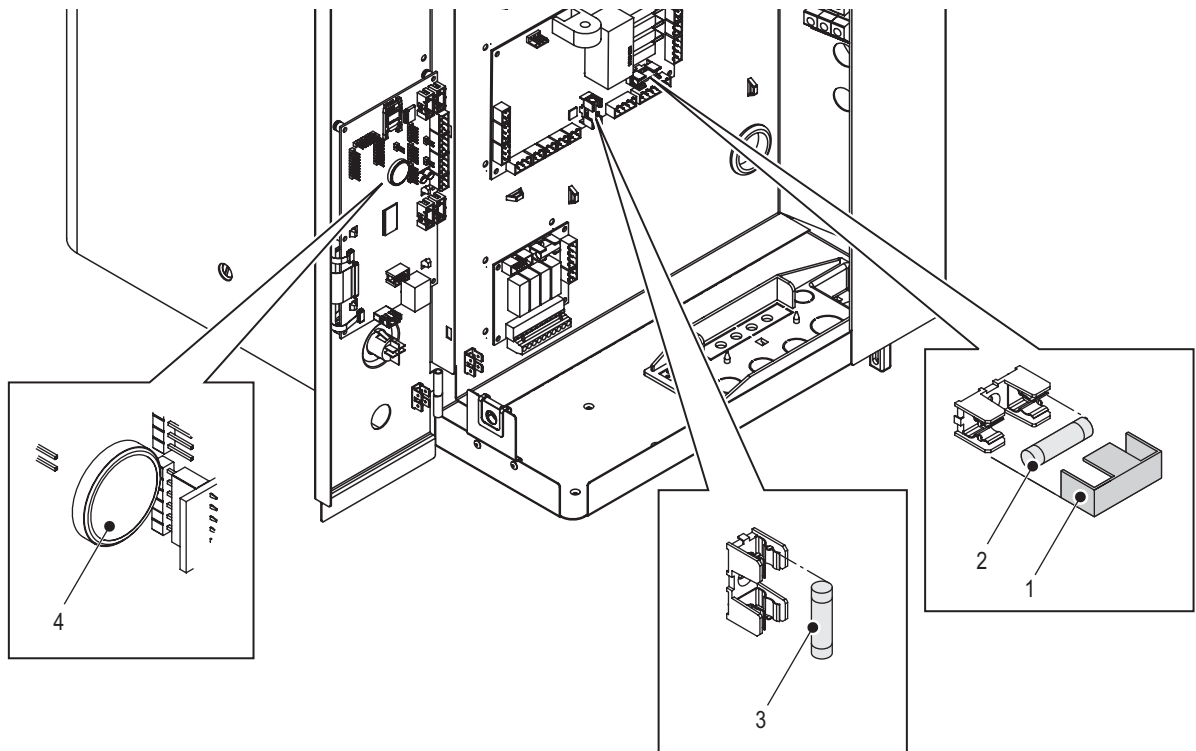

Figure 14: Backup Battery and Fuses Replacement

- 1 Protective cover
- 2 Fuse 4A, slow-acting
- 3 Fuse 1A, slow-acting
- 4 Battery 3V (CR 2032)

## 6.4 Cleaning

### 6.4.1 Cleaning Agents

Use only the cleaning agents described in the procedures below. Disinfectants may only be used if they do not leave behind toxic residue. Rinse all parts thoroughly with clean tap water after cleaning.

Follow all instructions, and observe the safety precautions stated below.



**CAUTION!**  
**Risk of damage to the humidifier components!**

**Do not** use solvents, aromatized or halogenized hydrocarbons, or other harsh chemicals for cleaning.

### 6.4.2 Cleaning Procedures

#### Water Hoses



Use a rubber mallet to knock out any scale buildup in the hoses. Rinse the hoses thoroughly with hot tap water.

#### Fill valve

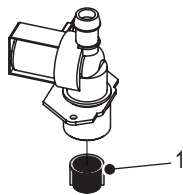

1 Strainer

Use a soft-bristled brush (not wire brush) to carefully remove any scale buildup inside the fill valve and in the strainer.

#### Drain Valve - Valve Body

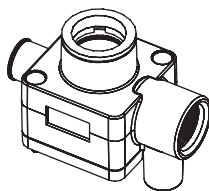

Use a soft-bristled brush (not wire brush) to remove any scale buildup inside the valve body of the drain valve.

## Fill Cup

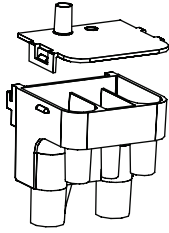

Release the two tabs and remove the cover on the fill cup.  
Use a soft-bristled brush (not wire brush) to remove any scale buildup inside the fill cup.  
Install the cover on the fill cup.

## Drain Cup

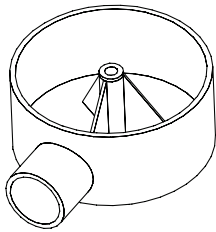

Use a soft-bristled brush (not wire brush) to carefully remove any scale buildup inside the drain cup.  
Wash the drain cup with lukewarm soap solution, and rinse thoroughly with tap water.

## 6.5 Resetting Cylinder



**WARNING!**  
Risk of damage to equipment and property!

**DO NOT reset the cylinder in the control software unless the steam cylinder has been replaced.**

Reset the cylinder in the control software as follows after replacing the steam cylinder(s):

1. Select the **<Menu>** button on the Home screen, then enter the password to login. Refer to "[Main Menu](#)" on page 25.
2. Select **Service > General Service tab > Cylinder A Reset**. A reset dialog appears prompts you to confirm the cylinder reset. **Note:** On units with dual steam cylinders, individually reset the appropriate maintenance counter – A, B, or both for the cylinder(s) replaced.
3. Select the **<Yes>** button on the confirmation screen. The Cylinder Status and the Cylinder Spent status message are reset.  
Select the **<No>** button at any time to abort the reset.



## 6.6 Installing Software and Firmware Updates

Install the updates for the control software or the driver board firmware as follows. Refer to [Figure 10 on page 61](#).

**Note:** If software update is accidentally interrupted, the humidifier will not operate, but the software update can be resumed by leaving the USB key inserted in the board and power cycling the unit. The integrated control board will detect the software was not properly installed, and restart the update.



**DANGER!**  
Risk of electric shock!

**The Nortec EL steam humidifier is mains powered. Live parts may be exposed when the door panels are removed. Touching live parts may cause severe injury or even death.**

**Prevention:** Shut down the humidifier properly at the external disconnect switch before accessing the control board in the humidifier.

1. Set the On/Off button to the Off position.
2. Disconnect the power supply to the humidifier at the external disconnect switch. To prevent accidental power-up, lockout and tag out according to the established safety practices at your facility.
3. Remove the door panel on the control cabinet in the humidifier – refer to ["Removal and Installation of Door Panels" on page 65](#).
4. Swing the front panel open.
5. Carefully insert the USB memory stick (formatted to 32-bit FAT system and containing the software updates) into the USB port. Make sure that the maximum length of the memory stick does not exceed 3 in (75 mm).
6. Close the front panel, and install the door panel.
7. Remove the lock and tag from the external disconnect switch, and restore power to the humidifier.
8. Set the On/Off button to the On position.
9. When the Home screen appears, select the **<Menu>** button, then enter the password to login.



**CAUTION!**  
Risk of file corruption!

**Do not** interrupt software and firmware updates once it starts. Wait until updating is completed. Corrupted control software or firmware can render the humidifier unusable.

**Note:** If software update is accidentally interrupted, the humidifier will not operate, but the software update can be resumed by leaving the USB key inserted in the board and power cycling the unit. The integrated control board will detect the software was not properly installed, and restart the update.

10. Select **Administrator > Software Settings tab > Software Update** to update the control software. Select **Driver Board A.DB.A** to update the firmware for the driver board. Or select **Driver Board A.DB.B** to update the firmware for the second driver board (on units with dual steam cylinders). A progress bar shows the status of the updating process. When updating is completed, the Home screen is displayed.  
**Note:** The software and firmware updates must be located at the root level on the USB memory stick.
11. Repeat [Step 1](#) to [Step 4](#), and carefully remove the USB memory stick.
12. Close the front panel and install the locking screw to secure it. Install the door panel making sure that it is fastened securely – refer to ["Removal and Installation of Door Panels" on page 65](#).
13. Repeat [Step 7](#) and [Step 8](#) to power up the humidifier.

This page intentionally left blank

# 7 Fault Isolation

## 7.1 General

Troubleshooting of the Nortec EL steam humidifier must only be performed by well qualified and well trained personnel. Electrical repairs must only be performed by a licensed electrician authorized by the customer or by Condair service technicians.

Troubleshooting the Nortec EL steam humidifier may require the user to access the inside of the control and plumbing cabinets in the humidifier which may expose the user and equipment to the hazards described below.



**DANGER!**  
Risk of electric shock!

**The Nortec EL steam humidifier is mains powered. Live parts may be exposed when the door panels are removed. Touching live parts may cause severe injury or even death.**

**Prevention:** Shut down the unit as described in "[Shutting Down](#)" on page 62 before performing any work inside the humidifier.



**CAUTION!**  
Electrostatic discharge (ESD)!



**The electronic components inside the control cabinet in the humidifier are sensitive to electrostatic discharge (ESD).**

**Prevention:** Take appropriate measures to protect the electronic components inside the unit against damage caused by electrostatic discharge (ESD). Refer to ANSI/ESD-S20.20.

## 7.2 Fault Indication

When a condition that is not normally expected occurs, it is detected by the control software and a warning or fault message is displayed in the Service/Warning/Fault status area of the Home screen (refer to [Figure 5 on page 15](#)). The warning and fault message types are described in [Table 8](#).

*Table 8: Maintenance/Fault Status Descriptions*

Message Type	Descriptions
 Warning	A condition with a "Warning" status is active. Typically, these conditions are of a temporary nature, or conditions that cannot cause damage to the system. Depending on the condition, the Nortec EL humidifier may be stopped or remains operable (unless the warning relates to a control signal). If the cause of the condition clears on its own accord, the warning message is automatically reset. If the condition becomes worse, a fault message may be triggered.  When a warning message is active, the status LED turns yellow in color.
 Fault	A condition with a "Fault" status is active. Typically, these are conditions which prevent further operation of the humidifier, or conditions that can cause damage to the system. When a fault condition occurs, the Condair EL humidifier stops steam production immediately.  When a fault message is active, the status LED turns red in color.

When a warning/fault condition occurs, select the warning or fault message to view the "Fault/Service History Tab" and additional details. Refer to [Figure 15](#).

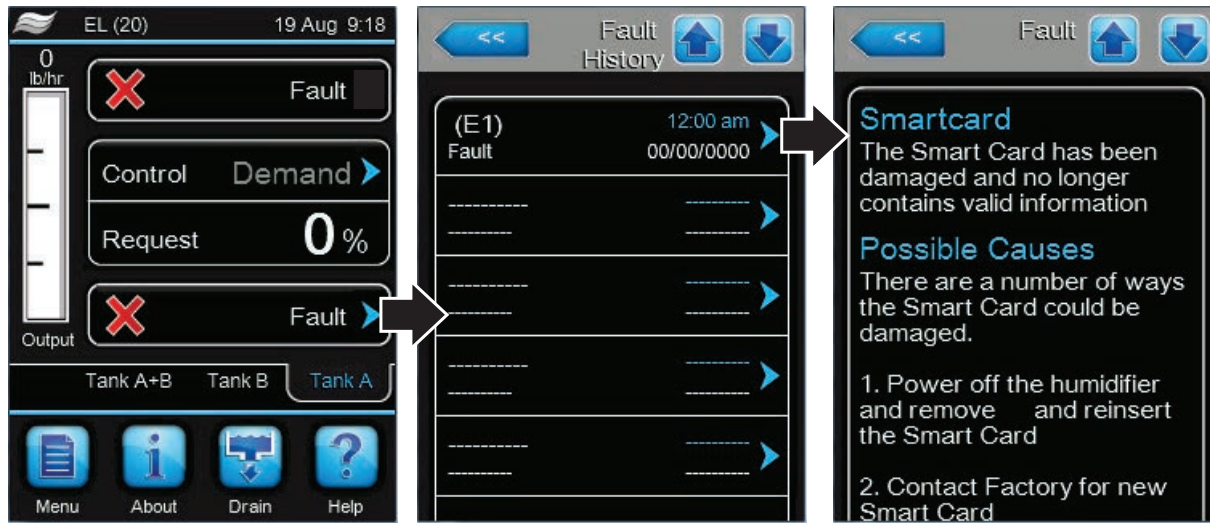

Figure 15: Fault History Screens

In addition, the [Service relay](#) in the optional remote fault indication PCB can also be set up to notify the user when a warning or maintenance notification message is triggered.

### 7.3 General Troubleshooting

Most operational warning/fault conditions are caused by improper installation, or by not adhering to the suggested best practices for installation of the humidifier and system components. Hence, a full fault diagnosis always requires a thorough examination of the entire system (hose connections, control systems, etc.).

[Table 9](#) to [Table 13](#) provide general guidelines for troubleshooting the Nortec EL humidifier and other auxiliary system components. For detailed troubleshooting information of the auxiliary system components, refer to their product manuals.

The list of Nortec EL warning and fault messages, and corrective actions are shown in [Table 14 on page 78](#).

#### Humidifier

Table 9: General Troubleshooting – Nortec EL Humidifier

Problem	Probable Cause	Corrective Action(s)
Nothing happens when the On/Off switch is turned On.	Blown fuse(s).	– Check the fuses ("F1" and "F3") on the driver board. Replace, if necessary.
	Incorrect voltage, or no voltage.	– Check the disconnect switch in the supply line.
	Step-down transformer not outputting 24 VAC.	– Replace the transformer. Verify primary wiring.

Problem	Probable Cause	Corrective Action(s)
Humidifier will not produce steam, or does not reach RH setpoint value.	Safety loop is open.	<ul style="list-style-type: none"> <li>– Check if the message "Safety Loop" is displayed in the operating status area of the Home screen.</li> <li>– Check if there is 24VAC supply at low voltage terminal strip contact "2".</li> <li>– Check that all On/Off devices connected to low voltage terminal strip contacts "1" and "2" are wired properly, and their contacts are closed when they should be.</li> </ul>
	Output is limited by the high limit humidistat signal.	– Check if the high limit humidistat is installed too close to the humidifier, and if it is operating correctly.
	No signal on Channel 1.	– Check voltage between low voltage terminal strip contacts "3" and "4". For a demand signal configuration, the signal must be 27% of full scale signal for the humidifier to start. For a transducer signal configuration, the signal must be lower than the setpoint value for the humidifier to start.
	No signal on Channel 2 (on units with <a href="#">Control Channels</a> set to "Dual").	– Check voltage between low voltage terminal strip contacts "3" and "5". For a demand signal configuration, the signal must be 27% of full scale signal for the humidifier to start. For a transducer signal configuration, the signal must be lower than the setpoint value for the humidifier to start.
	Capacity has been manually limited.	– Check/adjust <a href="#">Manual Capacity</a> , if necessary.
	Water conductivity is low.	– Check if the message "Max Level" is displayed in the operating status area of the Home screen. If the water conductivity is low, it may take several hours before the humidifier can reach full output capacity. This is quite normal. The steam cylinder is not drained to permit the mineral concentration (and hence conductivity) to rise.
Humidifier displays warning or fault message.	The control software has detected an abnormal condition.	– Refer to <a href="#">"Nortec EL Warning and Fault List" on page 78</a> .

## Steam Distributors

Table 10: General Troubleshooting – Steam Distributors

Problem	Probable Cause	Corrective Action(s)
Distributor spitting out water.	Distributor not level.	– Use end supports on the distributor to make sure that it is level.
	The condensate trap is too close to the distributor.	– The condensate trap must be located a minimum of 12 in (30 cm) below the distributor. Relocate, if necessary.
	Condensate line not sloped sufficiently.	– The condensate line must have a minimum downslope of 1.2°. Reinstall, if necessary.
	Clogged condensate trap.	– Make sure the traps allow water to flow freely.
	Condensate line has double traps in close proximity to each other.	– Condensate traps should not be in close proximity to each other, to prevent air locks.
	Steam line is not insulated.	– If steam line is too long, condensate build up could overload the distributor condensate port. Insulate the steam line to improve efficiency, and install additional condensate traps as required.
Condensation in duct.	Installation clearances not observed.	– Refer to distributor installation manual for required clearances. Relocate the distributor, if necessary.
	Design conditions changed.	– Check supply air temperature and humidity to determine if conditions have changed.
	High limit humidistat not functioning.	– Check setting and operation of high limit humidistat. Replace, if defective.
	Air proving switch not installed or not working	– Check that the humidifier will only operate when air is moving through the duct.
	Improper location of high limit humidistat.	– Check that the high limit humidistat is located where it can detect high duct humidity.

## SAM-e

Table 11: General Troubleshooting – SAM-e

Problem	Probable Cause	Corrective Action(s)
SAM-e spitting out water.	The condensate trap is too close to SAM-e.	– The condensate trap must be located a minimum of 12 in (30 cm) below the header. Relocate, if necessary.
	Condensate line not sloped sufficiently.	– The condensate line must have a minimum downslope of 1.2°. Reinstall, if necessary.
	Steam line is not insulated.	– If steam line is too long, condensate build up could overload the SAM-e condensate port. Insulate the steam line to improve efficiency, and install additional condensate traps as required.
SAM-e grommet leaks	Distributor tubes not seated properly.	– Push the distributor tubes down until support washer is resting on rubber grommet.
	Damaged grommet.	– Replace any damaged grommets.

## Blower Pack

Table 12: General Troubleshooting – Blower Pack

Problem	Probable Cause	Corrective Action(s)
Blower pack not operating. Note: The blower pack will not come on unless steam is produced by the humidifier.	No power to the blower pack.	– Check power connection. – Check blower pack fuses.
	Blower pack thermostat not closing.	– Check thermostat wiring. – Replace the thermostat if it's contact does not close when exposed to steam.

## Digital Humidistats

Table 13: General Troubleshooting – Digital Humidistats

Problem	Probable Cause	Corrective Action(s)
Humidistat reading humidity levels incorrectly.	Sensor out of calibration.	– Calibrate the sensor – refer to humidistat manual.
	Improper sensor location.	– Check that the humidistat is installed at a location which correctly represents the humidity in the room. Relocate, if necessary.
	Exposed to draft or heat source.	– Check that heat/cold fluctuations, drafts, sunlight, doors, or vents do not affect the humidity reading. Relocate, if necessary.
	No vapor barrier.	– Make sure that the vapor barrier is in place and working, so that drafts cannot affect the humidity reading.

## 7.4 Nortec EL Warning and Fault List

Table 14 shows the list of warning and fault messages triggered by the control software in the Nortec EL humidifier, and the corrective actions. The warning code escalates to a fault code if the alarm condition is not resolved within a certain period of time.

Table 14: Nortec EL Warning and Fault List

Code		Message	Probable Cause	Corrective Action(s)
Warning	Fault			
W01	E01	Smartcard	No communication with the SIM card.	
			No SIM card installed.	– Contact your local Condair representative.
			Defective SIM card.	– Contact your local Condair representative.

Code		Message	Probable Cause	Corrective Action(s)
Warning	Fault			
<b>W06</b>	–	Main Missing (or) Ext Missing	The link between the main unit and the extension unit in the Linkup chain is missing.	
			No communication between the main unit and the extension unit.	– Check/connect the bus cable.
			The main unit or the extension unit may be switched off.	– Switch on the main unit and/or the extension unit.
			The main unit may not be configured properly.	– Make sure that <i>Linkup Units</i> on the main unit is configured for the correct number of extension units in the Linkup chain.
<b>W07</b>	–	Ext Fault	An extension unit has a fault condition which was communicated to the main unit.	
			Alarm condition in the extension unit(s).	– Check the extension unit(s).
–	<b>E10</b>	CTRLR Fault (or) Memory (or) CTRLR Reset	Flash memory read/write fault.	– Contact your local Condair representative.
<b>W12</b>	–	On/Off Timer	The humidifier is turned off by the <i>On/Off timer</i> .	
<b>W21</b>	<b>E21</b>	Max. Level  No current (on fault)	Water level is at the top of the cylinder, or foaming was detected.	
			Humidifier has filled to the top of the cylinder without reaching demand.	– No action is required – for information purposes only. It is normal for a new cylinder to reach the maximum level before water in the cylinder is concentrated, and for an old cylinder to reach maximum level near the end of its life cycle.
				– If the cylinder is new, add ¼ tsp (1.25 ml) of salt to the fill cup to raise the conductivity level. – The conductivity of the water supply may be too low. Use potable water supply with conductivity greater than 150 µS/cm.
<b>W22</b>	<b>E22</b>	Fill T/O (timeout)	Permissible filling time exceeded.	
			Water supply line clogged, shutoff valve closed, or a clogged filter. Water pressure too low.	– Check the supply line, shutoff valve, filter and water pressure.
			Clogged or defective fill valve.	– Clean the strainer in the fill valve. Replace the fill valve, if necessary.
			Excessive backpressure in the steam line (duct pressure too high, steam line too long or kinked), causing water loss through the fill cup.	– Check duct pressure, inspect steam installation. If necessary, install the optional fill cup extension kit.
			Leaks in the water supply.	– Fix all water leaks.

Code		Message	Probable Cause	Corrective Action(s)
Warning	Fault			
W23	E23	Current T/O (timeout)	No heating current to electrodes.	
			Failure of one or more phases of the heating current.	<ul style="list-style-type: none"> <li>– Check the power supply. Check the optional primary fuse (if installed).</li> <li>– Check/replace the main contactor, if necessary.</li> </ul>
			Water supply line clogged, shutoff valve closed, or a clogged filter. Water pressure too low.	<ul style="list-style-type: none"> <li>– Check the supply line, shutoff valve, filter and water pressure.</li> </ul>
			Clogged or defective fill valve.	<ul style="list-style-type: none"> <li>– Clean the <a href="#">strainer in the fill valve</a>. Replace the fill valve,</li> </ul>
			Excessive backpressure in the steam line (duct pressure too high, steam line too long or kinked), causing water loss through the fill cup.	<ul style="list-style-type: none"> <li>– Check duct pressure, inspect steam installation. If necessary, install the optional fill cup extension kit.</li> </ul>
			Leaks in the water supply.	<ul style="list-style-type: none"> <li>– Fix all water leaks.</li> </ul>
W24	E24	Over Curr	Current draw in relation to the humidification demand is too high.	
			Humidity demand decreased too fast.	<ul style="list-style-type: none"> <li>– The system regulates current levels automatically to match the humidity demand.</li> </ul>
			Clogged drain valve.	<ul style="list-style-type: none"> <li>– Check/<a href="#">clean the drain valve</a>.</li> </ul>
			Excessive scale build-up in the steam cylinder.	<ul style="list-style-type: none"> <li>– Replace the steam cylinder, if necessary. Refer to "<a href="#">Removal and Installation of Steam Cylinder</a>" on page 66.</li> </ul>
			Water conductivity too high for the type of steam cylinder installed in the unit.	<ul style="list-style-type: none"> <li>– Contact your local Condair representative.</li> </ul>
W25	E25	Excess Curr	Maximum permissible current draw exceeded.	
			Clogged drain valve.	<ul style="list-style-type: none"> <li>– Check/<a href="#">clean the drain valve</a>.</li> </ul>
			Excessive scale build-up in the steam cylinder.	<ul style="list-style-type: none"> <li>– Replace the steam cylinder, if necessary. Refer to "<a href="#">Removal and Installation of Steam Cylinder</a>" on page 66.</li> </ul>
			Water conductivity too high for the type of steam cylinder installed in the unit.	<ul style="list-style-type: none"> <li>– Contact your local Condair representative.</li> </ul>
–	E26	Current Off	Current is detected when the controller has not energized the contactor.	
			Contactor jammed or short-circuited.	<ul style="list-style-type: none"> <li>– Check the secondary side of contactor. Replace the contactor, if necessary.</li> </ul>
			Current sensor on the driver board not seated properly, or defective.	<ul style="list-style-type: none"> <li>– Check the current sensor is seated properly on the driver board.</li> <li>– Replace the current sensor, if necessary.</li> </ul>



Code		Message	Probable Cause	Corrective Action(s)
Warning	Fault			
W27	E27	Foam Cyl Foaming Cyl (on fault)	Foam detected in the steam cylinder.	<ul style="list-style-type: none"> <li>– Manually Initiate drain of the steam cylinder – refer to <a href="#">"Manually Initiate Steam Cylinder Draining"</a> on page 59. Repeat several times, if necessary.</li> <li>– Check the quality of the water supply.</li> <li>– Check for restrictions and proper condensate removal in the steam line.</li> <li>– If water goes down the drain during the fill cycle, install a fill cup extension kit.</li> <li>– Install a filter to remove the organic material.</li> <li>– Clean the drain line.</li> <li>– Check that the humidifier can run normally long enough to perform a drain cycle. If not, enable the <a href="#">Short Cycle</a> feature.</li> </ul>
			Foam in the steam cylinder.	
			Backpressure may be preventing water from entering the cylinder.	
			Water may be contaminated with organic material.	
			Drain may be blocked due to over-concentration of minerals.	
			Humidifier short cycling.	
W28	–	Cylinder Spent	Steam cylinder replacement required.	<ul style="list-style-type: none"> <li>– Replace the steam cylinder – refer to <a href="#">"Removal and Installation of Steam Cylinder"</a> on page 66.</li> </ul>
			Electrodes in steam cylinder spent.	
–	E29	Cyl Fault	Steam cylinder replacement overdue.	<ul style="list-style-type: none"> <li>– Replace the steam cylinder – refer to <a href="#">"Removal and Installation of Steam Cylinder"</a> on page 66.</li> </ul>
			Electrodes in the steam cylinder fully spent.	
W32	–	CTRL Sigal (or) RH Signal	Invalid humidity demand signal.	<ul style="list-style-type: none"> <li>– Check connection.</li> <li>– Check/correct the <a href="#">Signal Type</a> setting for the sensor/humidistat in the control software.</li> <li>– Replace defective sensor/humidistat.</li> </ul>
			Humidity sensor/humidistat not connected correctly.	
			Signal type for the sensor/humidistat signal incorrectly configured (e.g. mA instead of V signal) in control software.	
			Defective humidity sensor/humidistat.	
W34	–	Rem Disable	The humidifier is disabled remotely by the BMS (building management system).	
W35	–	BMS T/O (timeout)	The maximum wait time without any communications from the BMS has been exceeded. If the signal <a href="#">Source</a> is set to "Analog", the humidifier will continue operating; otherwise it stops producing steam until communications with the BMS is re-established.	
W42	–	RH High	Sensed humidity is above the maximum value configured in the software.	<ul style="list-style-type: none"> <li>– Check the humidity control system.</li> <li>– Adjust the <a href="#">proportional and/or integral value</a> of the controller.</li> <li>– Run the humidifier with <a href="#">Capacity Limitation</a>.</li> <li>– Adjust the RH High value for the sensor signal.</li> </ul>
			Incorrect layout of the humidity control system, or defective components.	
			Humidifier capacity too large for the space being humidified.	
			The <a href="#">RH High</a> value for the sensor signal is set too low.	
W43	–	RH Low	Sensed humidity is below the minimum value configured in the software.	<ul style="list-style-type: none"> <li>– Check the humidity control system.</li> <li>– Adjust the RH Low value for the sensor signal.</li> </ul>
			Incorrect layout of the humidity control system, or defective components.	
			The <a href="#">RH Low</a> value for the sensor signal is set too high.	

Code		Message	Probable Cause	Corrective Action(s)
Warning	Fault			
W57	-	Startup Code	Activation code required to use the humidifier.	
			Activation code missing.	- Contact your local Condair representative.
W71	-	Low Cond	Water conductivity may be too low.	
			Water conductivity too low for the type of steam cylinder installed in the unit.	- Contact your Condair representative.
			Leak around the drain valve.	- Fix any leaks between the steam cylinder and the drain valve. If necessary, clean the drain valve.
			Backpressure may be causing fill water to go down the drain.	- Check for restrictions and proper condensate removal in the steam line. - If water goes down the drain during the fill cycle, install a fill cup extension kit.
			Newly installed cylinder not reaching demand for extended period of time due to low conductivity.	- Add ¼ tsp (1.25 ml) of salt to the fill cup to raise the conductivity level. - Adjust the <i>D(rain) Factor</i> to 0.7. - Enable <i>Low Conductivity</i> .
			Conductivity level of water supply may be too low.	- Contact your Condair representative.
-	E84	Driver Bd	No communication between the controller and the driver board.	
			Communication cable between the driver board and the control board not connected properly.	- Make sure the RS485 cable is connected to RS4851 on the driver board and J12 on the control board.
			SW1 switch on the driver board may not be set correctly.	- Set the SW1 switch to "0" on driver board A, and "1" on driver board B, and power cycle the humidifier.
			Unspecified driver board fault.	- Contact your Condair representative.
-	E128	Curr Sensor	The current sensor cannot be calibrated on system startup.	
			Current sensor not connected properly.	- Check the current sensor is connected properly.
			Defective current sensor.	- Contact your local Condair representative.

## 7.1 Exporting Fault and Service History

Export the humidifier fault and service history data to a USB memory stick as follows. Refer to [Figure 10 on page 61](#).



**DANGER!**  
Risk of electric shock!

**The Nortec EL steam humidifier is mains powered. Live parts may be exposed when the door panels are removed. Touching live parts may cause severe injury or even death.**

**Prevention:** Shut down the unit as described in "[Shutting Down](#)" on page 62.

1. Set the On/Off button to the Off position.
2. Disconnect the power supply to the humidifier at the external disconnect switch. To prevent accidental power-up, lockout and tag out according to the established safety practices at your facility.
3. Remove the door panel on the control cabinet in the humidifier – refer to "[Removal and Installation of Door Panels](#)" on page 65.
4. Swing the front panel open.

---

**CAUTION!** Any previous history data on the memory stick will be over-written.

---

5. Carefully insert a USB memory stick (formatted to 32-bit FAT system) into the USB port. Make sure that the maximum length of the memory stick does not exceed 3 in (75 mm).
6. Close the front panel, and install the door panel.
7. Remove the lock and tag from the external disconnect switch, and restore power to the humidifier.
8. Set the On/Off button to the On position.
9. When the Home screen appears, select the **<Menu>** button, then enter the password to login.
10. Select **Service > Fault/Service History tab > Export History**. The last 40 humidifier fault/service history events are then downloaded to the memory stick as separate files labelled WARNING\_FAULT.csv and SERVICE\_HISTORY.csv.  
Press the **<Cancel>** button at any time to abort the operation.
11. Repeat [Step 1](#) to [Step 4](#), and carefully remove the USB memory stick.
12. Close the front panel. Install the door panel making sure that it is fastened securely – refer to "[Removal and Installation of Door Panels](#)" on page 65.
13. Repeat [Step 7](#) and [Step 8](#) to power up the humidifier.

## 7.2 Resetting Fault Status

Reset a condition in the humidifier with a "Fault" status as follows:

1. Set the On/Off button to the Off position.
2. Wait approximately for 5 seconds, then set the On/Off button to the On position.  
If the alarm condition has been eliminated, the fault message is automatically reset; otherwise the fault message reappears after a short while.

This page intentionally left blank

# 8 Wiring Diagrams

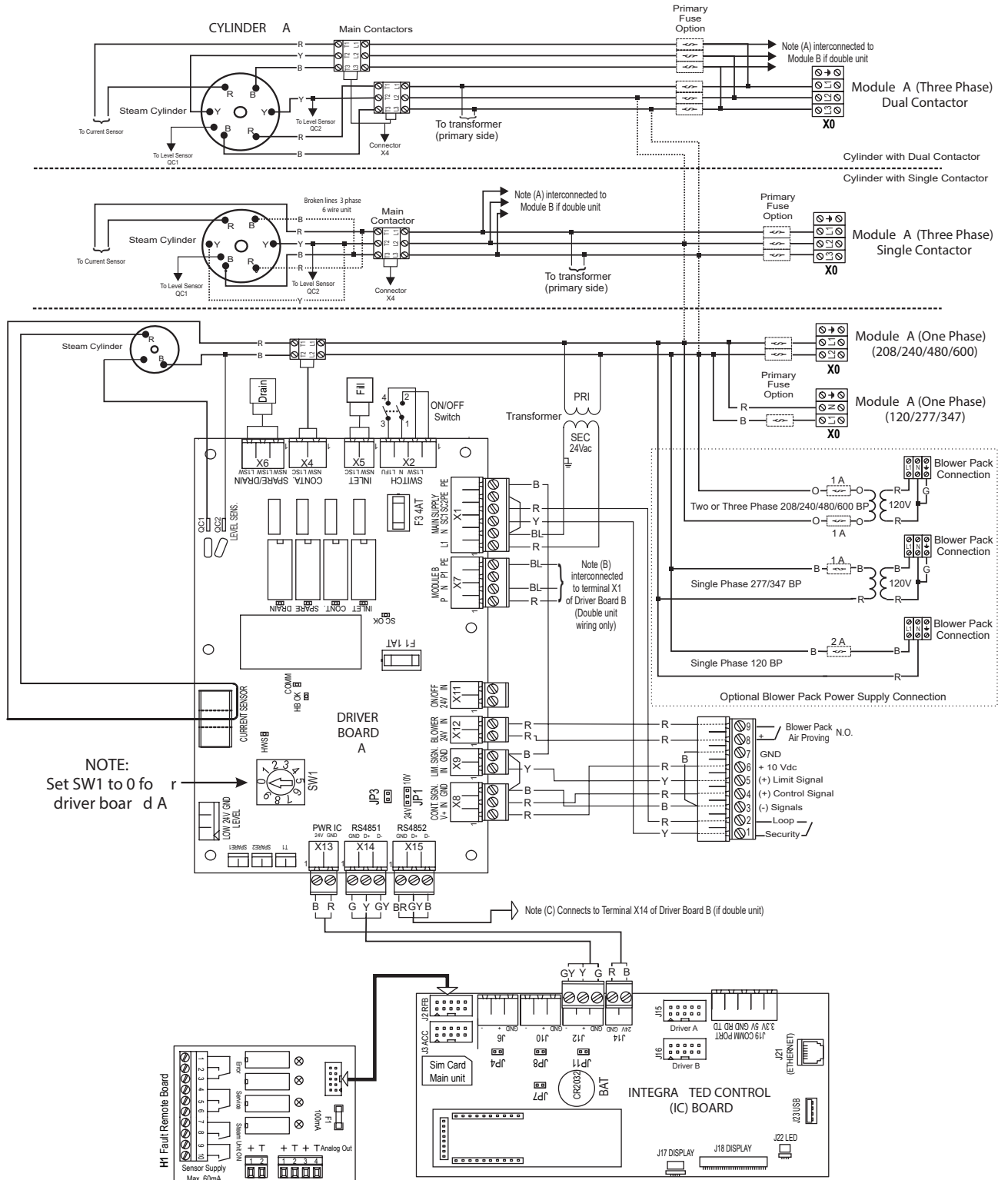

Figure 16: Wiring Diagram - Nortec EL Humidifier, Steam Cylinder A (Module A)

Legend: (Figure 16)

- F1 Internal fuse, driver board (1A, slow-acting)
- F3 Internal fuse, driver board (4A, slow-acting)
- JP4 Jumper for activating the termination resistor for Modbus or BACnet MSTP network.
- J6 Modbus connector (RS485 interface)
- JP7 Jumper for activating Modbus or BACnet MSTP communication via connector J6.
- JP8 Termination, Linkup system
- J10 Linkup connector
- K1 Main contactor, supply voltage
- LV Low voltage terminal strip A
- SW1 Rotary switch, module identification (Module A: 0)
- X0 Terminal block, supply voltage

Figure 17 shows the wiring diagram for large humidifiers with a second steam cylinder (usually referred to as Cylinder B). Connections carried over from Figure 16 on page 85.

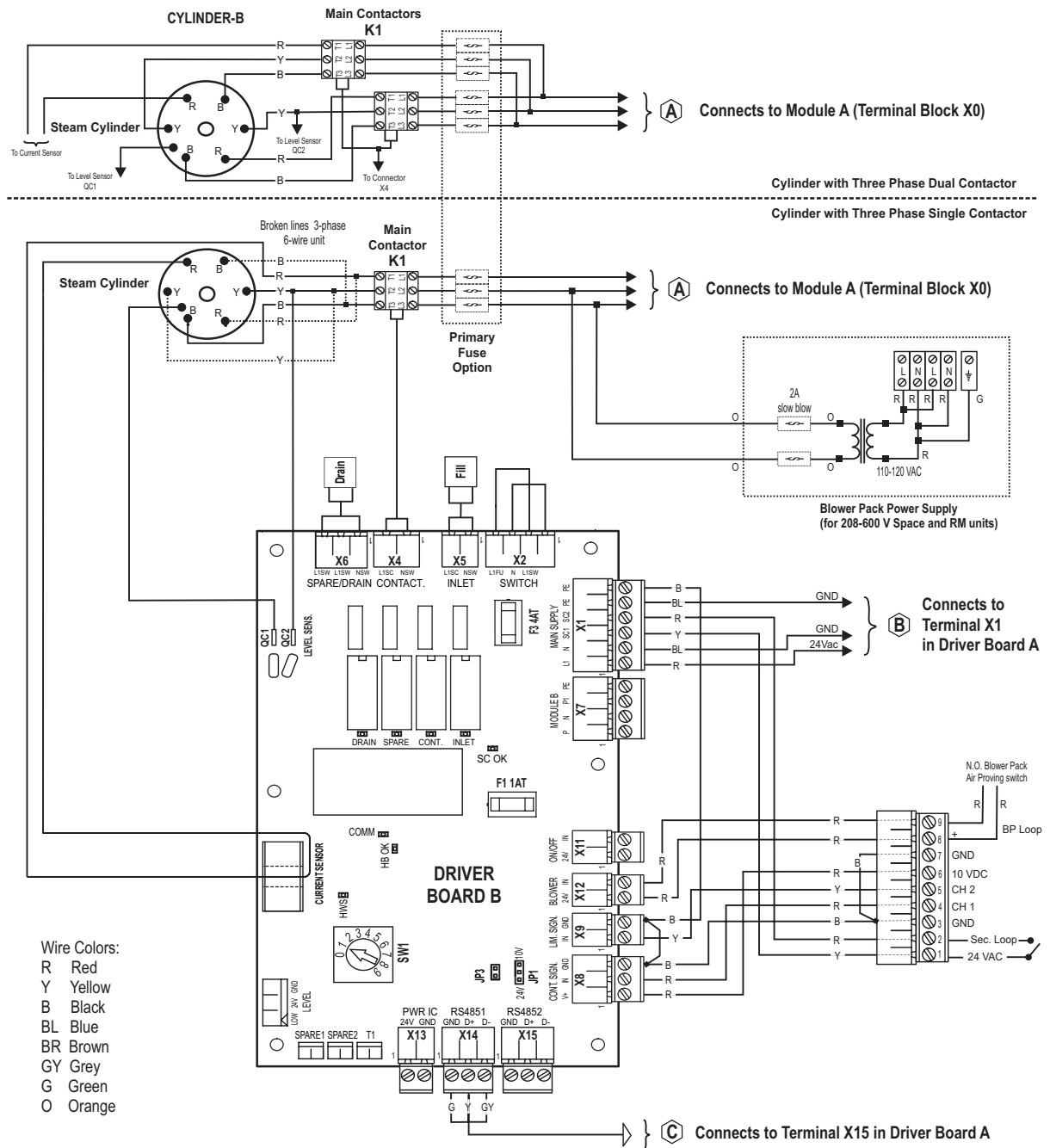

Figure 17: Wiring Diagram - Nortec EL Humidifier, Steam Cylinder B (Module B)

Legend:

- F1 Internal fuse, driver board (1A, slow-acting)
- F3 Internal fuse, driver board (4A, slow-acting)
- K1 Main contactor, supply voltage
- LV Low voltage terminal strip B
- SW1 Rotary switch, module identification (Module B: 1)

This page intentionally left blank



# 9 Decommissioning

## 9.1 General

If the Nortec EL steam humidifier needs to be removed from service (for disposal or long-term storage), strictly follow all instructions in this chapter.

### Personnel Qualifications

Decommissioning of the Nortec EL steam humidifier must only be performed by a qualified service technician authorized by the customer. It is the customer's responsibility to verify qualifications of the personnel.

### Safety

Decommissioning of the Nortec EL steam humidifier may require the user to access the inside of the control and plumbing cabinets in the humidifier which may expose the user and equipment to the hazards described below.



**DANGER!**  
Risk of electric shock!

**The Nortec EL steam humidifier is mains powered. Live parts may be exposed when the door panels are removed. Touching live parts may cause severe injury or even death.**

**Prevention:** Shut down the unit as described in ["Shutting Down" on page 62](#) before proceeding.



**WARNING!**  
Risk of severe burns from exposure of skin to hot water or hot steam vapours!

**The water in the steam cylinder(s) in the humidifier can be up to 203°F (95°C). Contact with the hot water or hot steam vapours can result in severe burns.**

**Prevention:** Shut down the unit as described in ["Shutting Down" on page 62](#) and wait for the unit to cool down before proceeding.



**WARNING!**  
Risk of severe burns from contact with hot surfaces!

**Components of the steam system may reach 212°F (100°C) during operation. Contact with the hot surfaces can result in severe burns.**

**Prevention:** Avoid touching any components in the plumbing cabinet until the unit has cooled down to room temperature.



**CAUTION!**  
Electrostatic discharge (ESD)!

**The electronic components inside the control cabinet in the humidifier are very sensitive to electrostatic discharge (ESD).**

**Prevention:** Take appropriate measures to protect the electronic components inside the unit against damage caused by electrostatic discharge (ESD). Refer to ANSI/ESD-S20.20.

## 9.2 Removal from Service for Disposal or Long-term Storage

Remove the Nortec EL humidifier from service (for disposal or long-term storage) as follows:

1. Drain the steam cylinder, and shut down the humidifier as described in ["Shutting Down" on page 62](#). Follow all safety precautions.
2. Disconnect and remove the power supply to the Nortec EL humidifier. Refer to ["Wiring Diagrams" on page 85](#).
3. Disconnect and remove the control signal inputs to the humidifier.
4. Disconnect the steam and condensate lines, and empty out all fluids.
5. Disconnect the water and drain connections to the humidifier.
6. Remove the humidifier from its mounting surface.
7. If the Nortec EL humidifier is to be put into long-term storage, store the humidifier in its original packaging inside a protected area that meets the following requirements:
  - Room temperature: 41 to 104 °F (5 to 40 °C)
  - Room humidity: 10 to 75% RH
8. If the Nortec EL humidifier is to be disposed off, refer to ["Disposal/Recycling"](#).

## 9.3 Disposal/Recycling

The Nortec EL steam humidifier should not be disposed off in domestic waste, and should only be disposed off in accordance with local regulations at authorized collection facilities.

If you have any questions, please contact the appropriate local authorities or your local Condair representative.

# 10 Product Specifications

## 10.1 Performance Data

Housing Size	Nortec EL Model	110-120V/1~			208V/1~			220-240V/1~			277V/1~			380-415V/1~			440-480V/1~			550-600V/1~		
		lb/h (kg/h)	kW	A	lb/h (kg/h)	kW	A	lb/h (kg/h)	kW	A	lb/h (kg/h)	kW	A	lb/h (kg/h)	kW	A	lb/h (kg/h)	kW	A	lb/h (kg/h)	kW	A
S	005	5 (2.2)	1.9	15.6	-	-	-	-	-	-	-	-	-	-	-	-	-	-	-	-	-	-
	010	-	-	-	10 (4.5)	3.7	18.0	10 (4.5)	3.7	15.6	10 (4.5)	3.7	13.5	10 (4.5)	3.7	9.0	10 (4.5)	3.7	7.8	10 (4.5)	3.7	6.2
	020	-	-	-	20 (9)	7.5	36.0	20 (9)	7.5	31.2	20 (9)	7.5	27.0	20 (9)	7.5	18.0	20 (9)	7.5	15.6	20 (9)	7.5	12.5
	030	-	-	-	-	-	-	-	-	-	-	-	-	-	-	-	-	-	-	-	-	-
M	050	-	-	-	-	-	-	-	-	-	-	-	-	-	-	-	-	-	-	-	-	-
	075	-	-	-	-	-	-	-	-	-	-	-	-	-	-	-	-	-	-	-	-	-
	100	-	-	-	-	-	-	-	-	-	-	-	-	-	-	-	-	-	-	-	-	-
L	150*	-	-	-	-	-	-	-	-	-	-	-	-	-	-	-	-	-	-	-	-	-
	200*	-	-	-	-	-	-	-	-	-	-	-	-	-	-	-	-	-	-	-	-	-

Housing Size	Nortec EL Model	208V/3~			220-240V/3~			380V/3~			440-480V/3~			550-600V/3~		
		lb/h (kg/h)	kW	A	lb/h (kg/h)	kW	A	lb/h (kg/h)	kW	A	lb/h (kg/h)	kW	A	lb/h (kg/h)	kW	A
S	005	-	-	-	-	-	-	-	-	-	-	-	-	-	-	
	010	-	-	-	-	-	-	-	-	-	-	-	-	-		
	020	20 (9)	7.5	20.8	20 (9)	7.5	18.0	20 (9)	7.5	10.4	20 (9)	7.5	9.0	20 (9)	7.5	7.2
	030	30 (13.6)	11.2	31.1	30 (13.6)	11.2	27.0	30 (13.6)	11.2	15.6	30 (13.6)	11.2	13.5	30 (13.6)	11.2	10.8
M	050	50 (22.7)	18.7	51.9	50 (22.7)	18.7	45.0	50 (22.7)	18.7	26.0	50 (22.7)	18.7	22.5	50 (22.7)	18.7	18.0
	075	75 (34)	28.1	77.9	75 (34)	28.1	67.5	75 (34)	28.1	39.0	75 (34)	28.1	33.7	75 (34)	28.1	27.0
	100	90 (41)	33.7	93.4	100 (45)	37.4	90.0	100 (45)	37.4	52.0	100 (45)	37.4	45.0	100 (45)	37.4	36.0
L	150*	150 (68)	56.1	155.7	150 (68)	56.1	135.0	150 (68)	56.1	78.0	150 (68)	56.1	67.5	150 (68)	56.1	54.0
	200*	180 (82)	67.3	186.9	200 (91)	74.8	180.0	200 (91)	74.8	104.1	200 (91)	74.8	90.0	200 (91)	74.8	72.0

## 10.2 Operating Data

Control Signal Input Type:	
Active	0-5VDC, 1-5VDC, 0-10VDC, 2-10VDC, 0-20VDC, 0-16VDC, 3.2-16VDC, 0-20mADC, 4-20mADC
Passive	135-10kΩ ohmic humidity sensor
On/Off control	<2.5VDC Off 2.5-20VDC On

Ambient Conditions:	
Ambient temperature	41-104 °F (5-40 °C)
Relative humidity	5-95% (non-condensing)

Backpressure:	
Maximum permissible back-pressure (duct static pressure and line backpressure)	5.5 in H <sub>2</sub> O (1.37 kPa) Up to 10 in H <sub>2</sub> O (2.49 kPa) with optional fill cup extension

Water Supply:	
Water pressure (regulated)	30-80 psig (207-550 kPa)
Flow rate	Minimum 0.9 gpm (3.3 L/min)
Water temperature	34-104 °F (1-40 °C)
Water quality	Cold potable water filtered to 5 µm (optional), with conductivity of 150-1200 µS/cm (hardness 0-12 gpg when silica is between 0-4 ppm, 0-3 gpg when silica is between 4-14 ppm, silica content above 14 ppm is not recommended), and pH level between 7-7.5

Drain Water:	
Drain water temperature	140 °F (60 °C) maximum
Drainage capacity	Minimum 2.3 gal/min (8.7 L/min) per steam cylinder

Power:	
Maximum current draw	Refer to the specification label on the unit.
Maximum external fuse rating	Refer to the specification label on the unit.

## 10.3 Size and Weight

### 10.3.1 Size

Model	Housing Size	Dimensions (W×D×H)
Nortec EL	Small	16.5 × 14.5 × 26.4 in (418 × 370 × 670 mm)
	Medium	20.9 × 15.8 × 30.7 in (530 × 400 × 780 mm)
	Large	39.4 × 15.8 × 30.7 in (1000 × 400 × 780 mm)
Nortec EL Space	Small	16.5 × 15.8 × 35.2 in (418 × 400 × 893 mm)
	Medium	20.9 × 16.3 × 39.5 in (530 × 415 × 1003 mm)

### 10.3.2 Weight

Model	Housing Size	Net Weight	Operating Weight
Nortec EL	Small	45 lb (21 kg)	65 lb (30 kg)
	Medium	85 lb (39 kg)	150 lb (68 kg)
	Large	120 lb (55 kg)	245 lb (112 kg)
Nortec EL Space	Small	83 lb (38 kg)	103 lb (47 kg)
	Medium	123 lb (56 kg)	188 lb (85 kg)

**Notes**

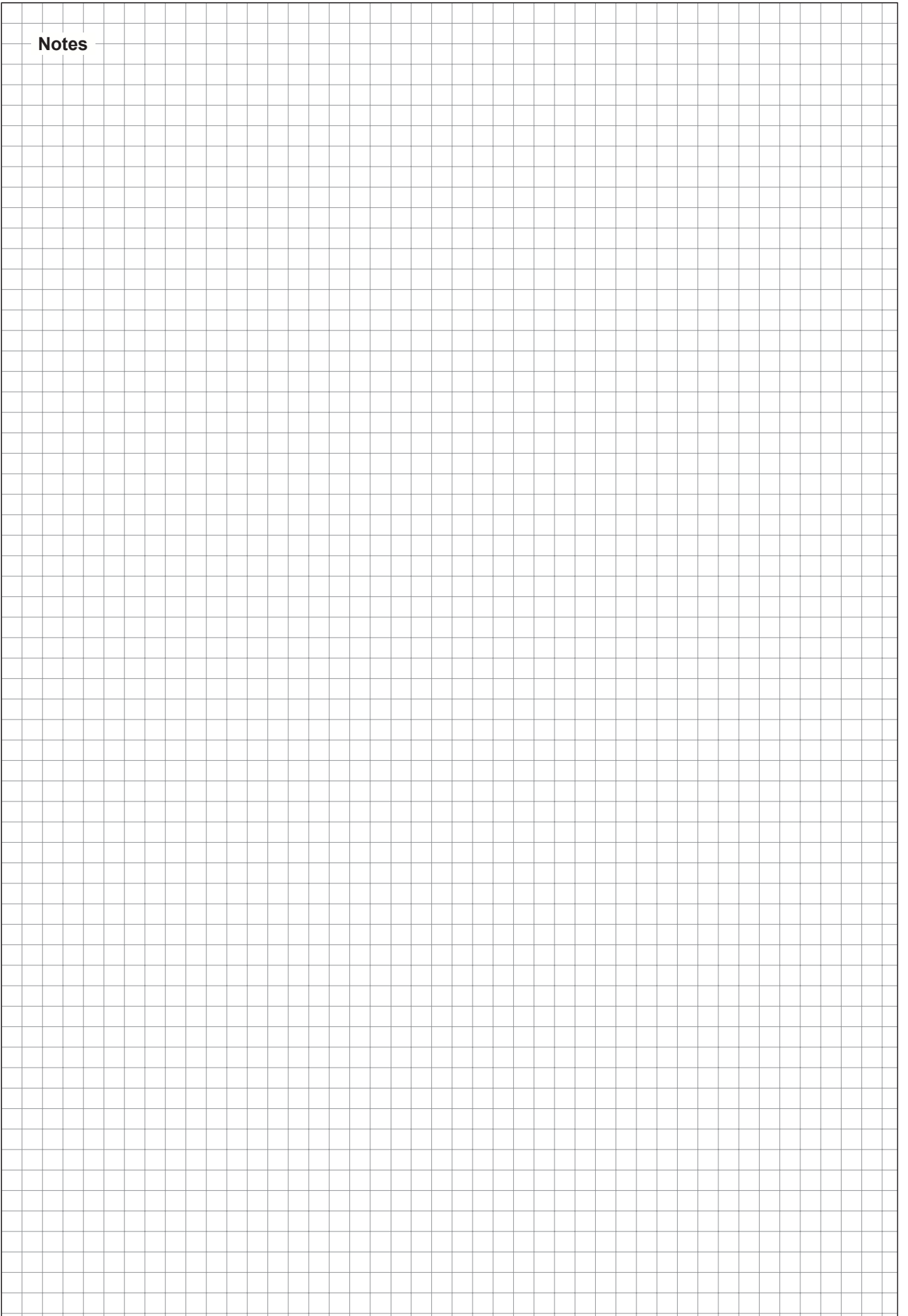

**Notes**

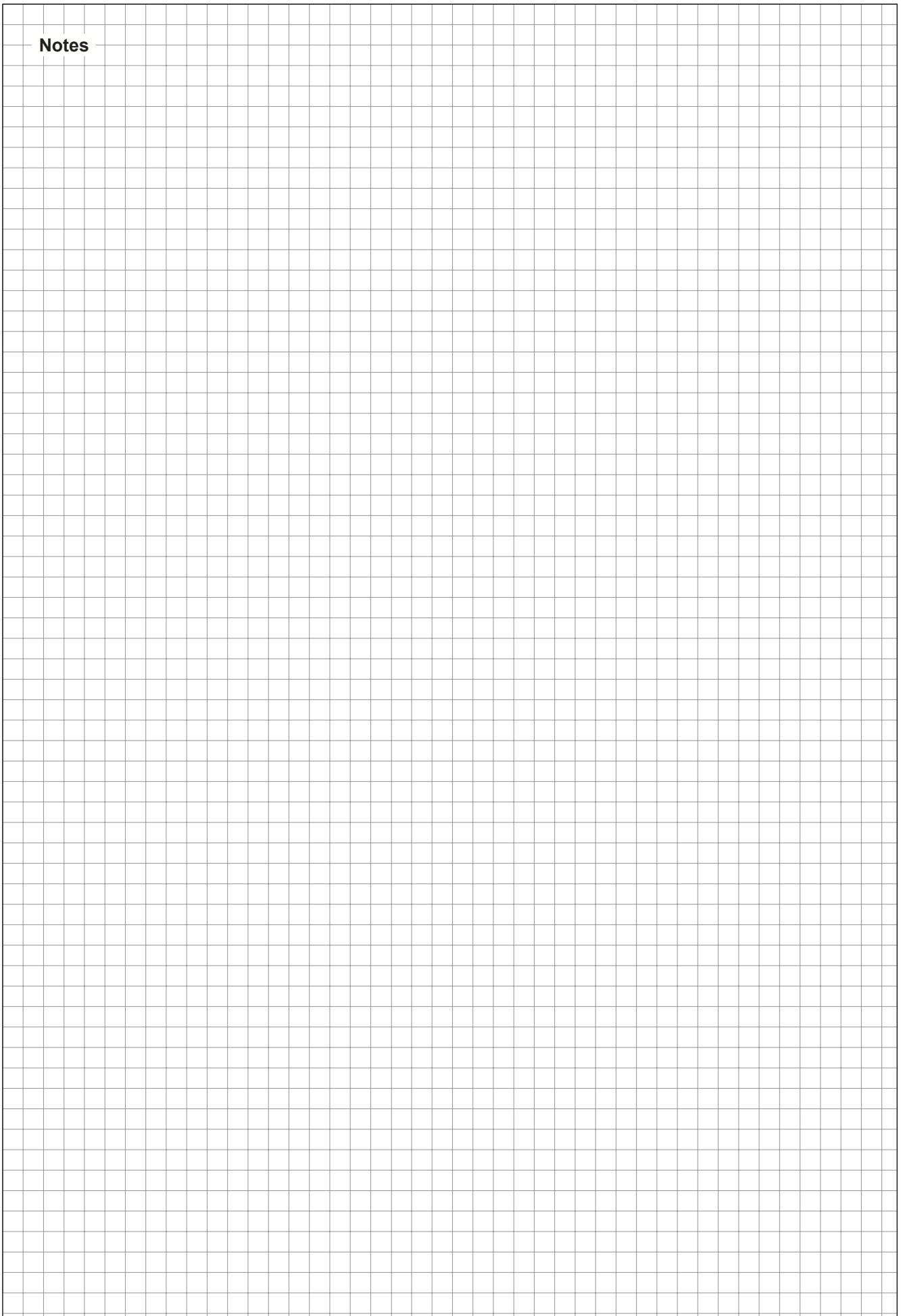

# Warranty

Condair Inc. and/or Condair Ltd. (hereinafter collectively referred to as THE COMPANY), warrant for a period of two years after installation or 30 months from manufacturer's ship date, whichever date is earlier, that THE COMPANY's manufactured and assembled products, not otherwise expressly warranted, are free from defects in material and workmanship. No warranty is made against corrosion, deterioration, or suitability of substituted materials used as a result of compliance with government regulations.

THE COMPANY's obligations and liabilities under this warranty are limited to furnishing replacement parts to the customer, F.O.B. THE COMPANY's factory, providing the defective part(s) is returned freight prepaid by the customer. Parts used for repairs are warranted for the balance of the term of the warranty on the original humidifier or 90 days, whichever is longer.

The warranties set forth herein are in lieu of all other warranties expressed or implied by law. No liability whatsoever shall be attached to THE COMPANY until said products have been paid for in full and then said liability shall be limited to the original purchase price for the product. Any further warranty must be in writing, signed by an officer of THE COMPANY.

THE COMPANY's parts or materials that are considered consumables, including but not limited to: cylinders, filters, nozzles, membranes, media, gaskets, O-rings, etc. are NOT covered by the warranty.

THE COMPANY makes no warranty and assumes no liability unless the equipment is installed in strict accordance with a copy of the catalog and installation manual in effect at the date of purchase and by a contractor approved by THE COMPANY to install such equipment.

THE COMPANY makes no warranty and assumes no liability whatsoever for consequential damage or damage resulting directly from misapplication, incorrect sizing or lack of proper maintenance of the equipment.

THE COMPANY makes no warranty and assumes no liability whatsoever for damage resulting from freezing of the humidifier, supply lines, drain lines, or quality of the water used.

THE COMPANY retains the right to change the design, specification and performance criteria of its products without notice or obligation.

THE COMPANY's limited warranty on accessories, not of the companies manufacture, such as controls, humidistats, pumps, etc. is limited to the warranty of the original equipment manufacturer from date of original shipment of humidifier.

## **Extended Warranty**

Extended warranties are available to purchase under the conditions listed above.



CONSULTING, SALES AND SERVICE:

**U.S.A.**

835 Commerce Park Drive,  
Ogdensburg, NY 1366-2209

**CANADA**

2740 Fenton Road  
Ottawa, ON, K1T 3T7

Tel: 1.866.667.8321  
Fax: 613.822.7964

Email: [na.info@condair.com](mailto:na.info@condair.com)  
Website: [www.condair.com](http://www.condair.com)

